

Proteomics & Bioinformatics Part II

David Wishart

3-41 Athabasca Hall

david.wishart@ualberta.ca

3 Kinds of Proteomics*

- **Structural Proteomics**
 - High throughput X-ray Crystallography/Modelling
 - High throughput NMR Spectroscopy/Modelling
- **Expressional or Analytical Proteomics**
 - Electrophoresis, Protein Chips, DNA Chips, 2D-HPLC
 - Mass Spectrometry, Microsequencing
- **Functional or Interaction Proteomics**
 - HT Functional Assays, Ligand Chips
 - Yeast 2-hybrid, Deletion Analysis, Motif Analysis

Historically...

- **Most of the past 100 years of biochemistry has focused on the analysis of small molecules (i.e. metabolism and metabolic pathways)**
- **These studies have revealed much about the processes and pathways for about 400 metabolites which can be summarized with this...**

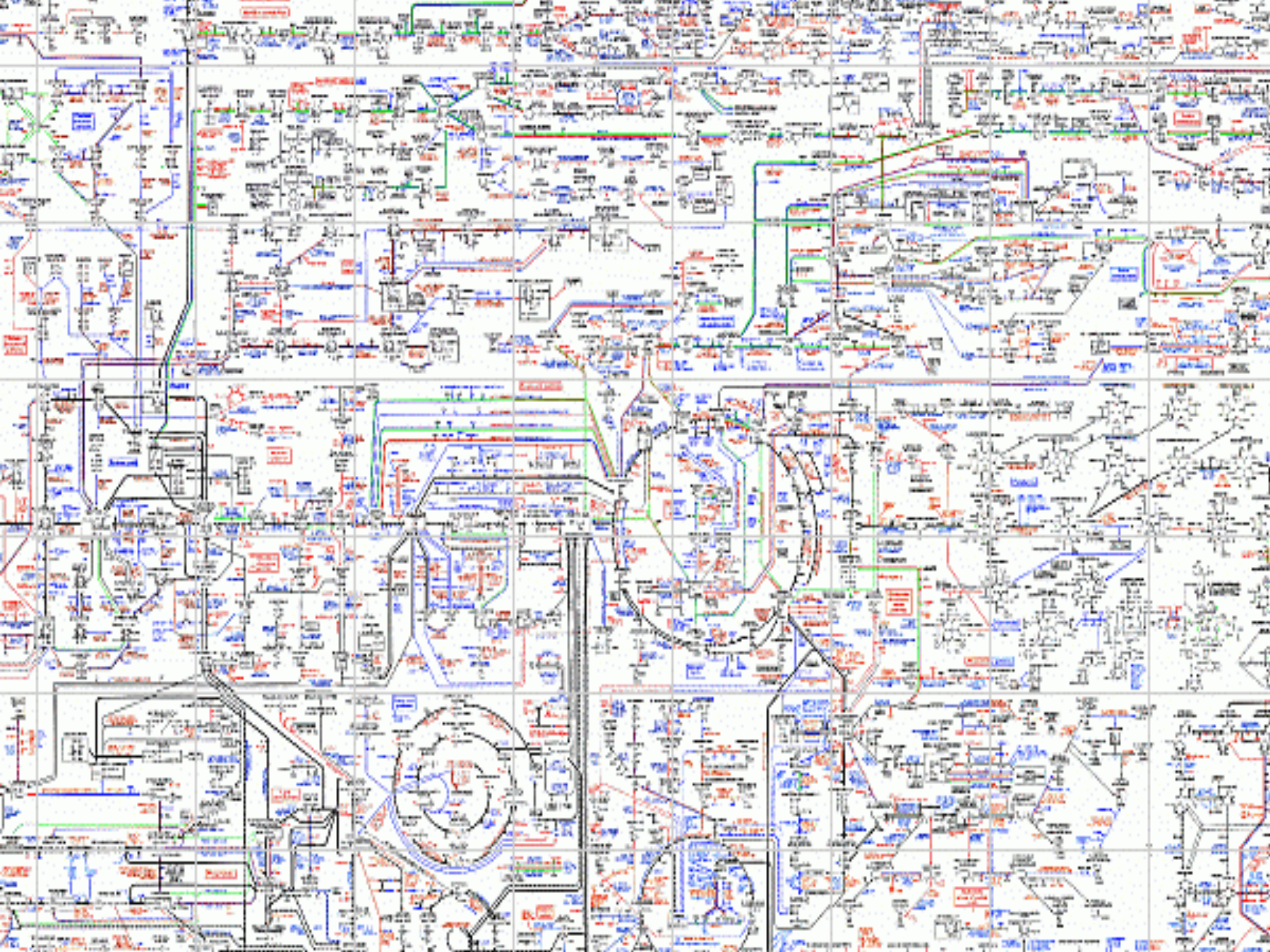

More Recently...

- **Molecular biologists and biochemists have focused on the analysis of larger molecules (proteins and genes) which are much more complex and much more numerous**
- **These studies have primarily focused on identifying and cataloging these molecules (Human Genome Project)**

Nature's Parts Warehouse

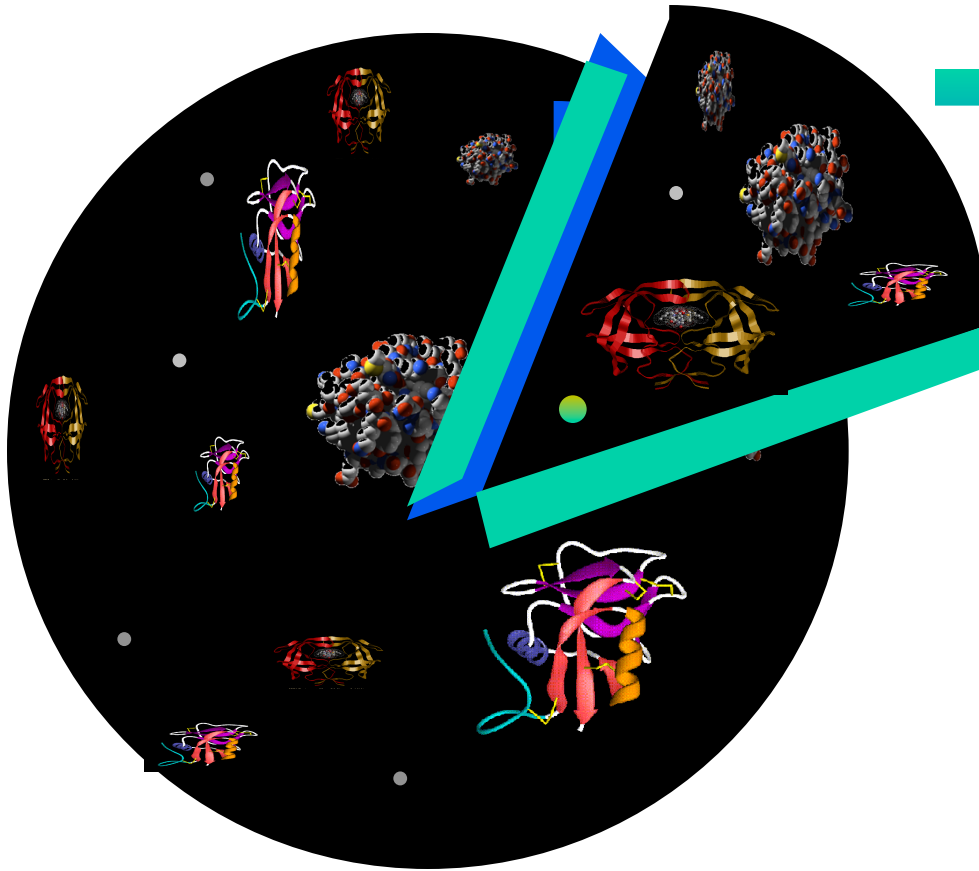

The protein universe

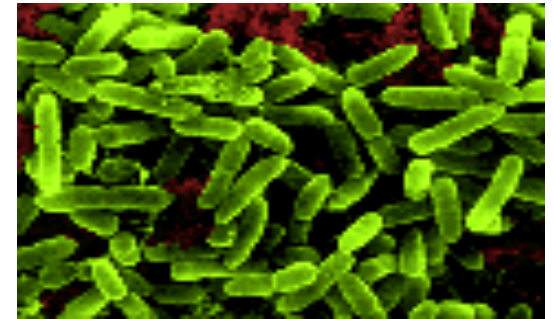

Living cells

The Protein Parts List

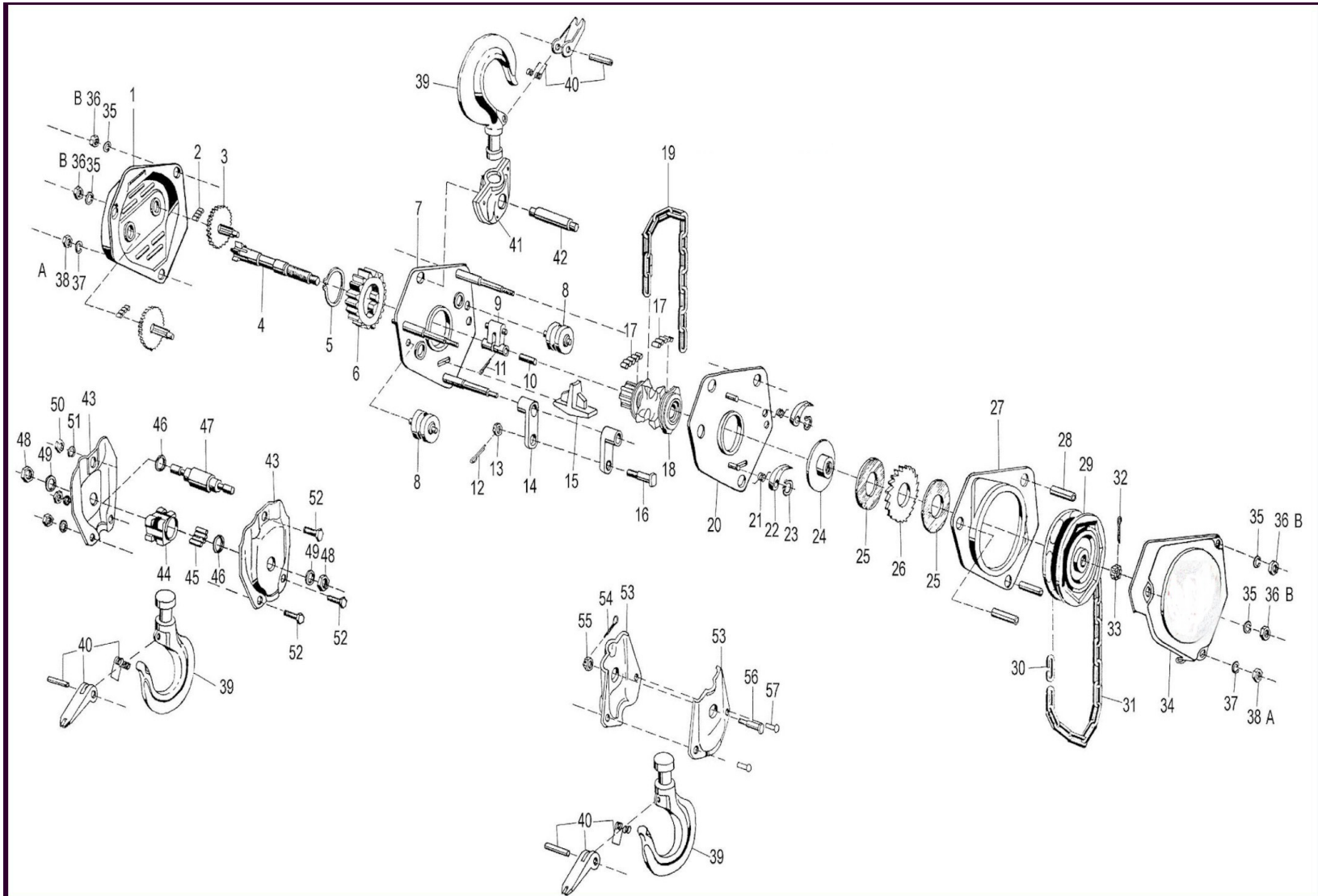

However...

- This cataloging (which consumes most of bioinformatics) has been derogatively referred to as “stamp collecting”
- Having a collection of parts and names doesn't tell you how to put something together or how things connect -- *this is biology*

Remember: *Proteins Interact**

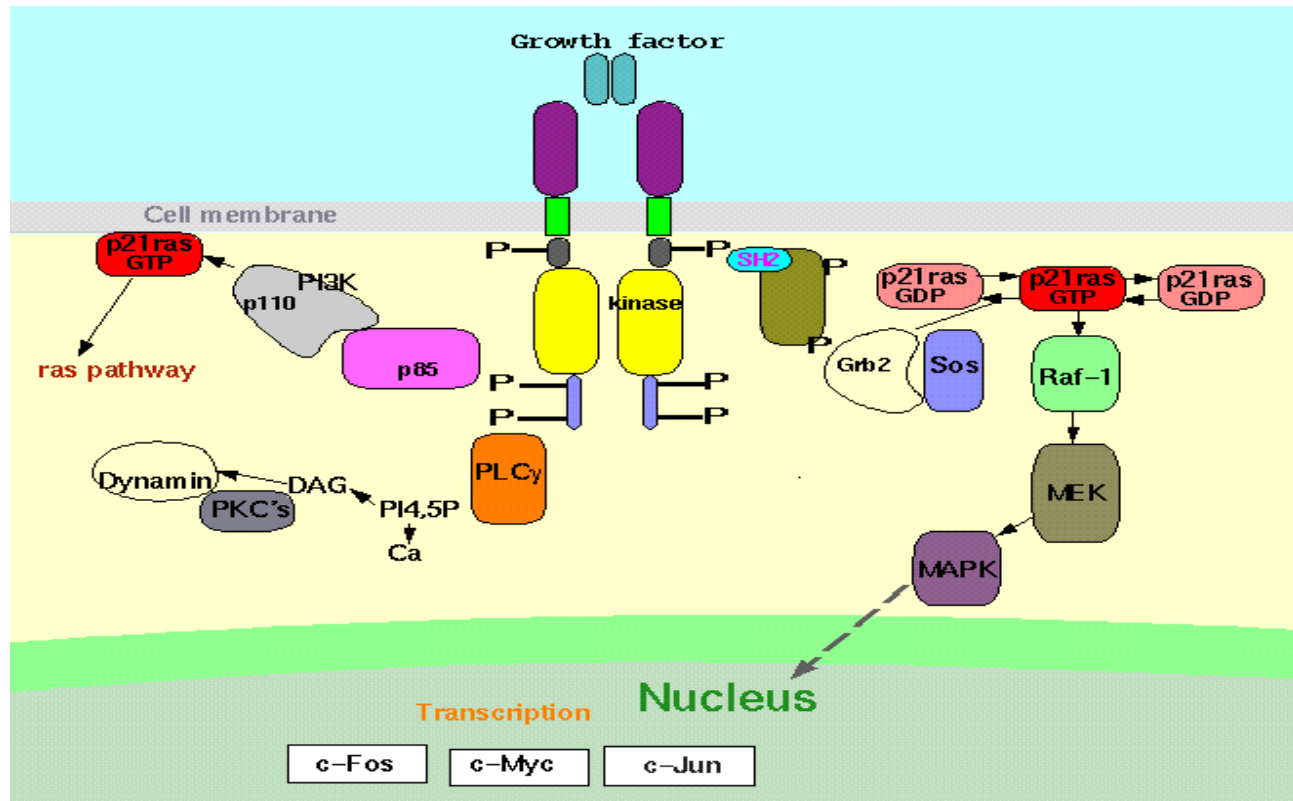

Proteins Assemble*

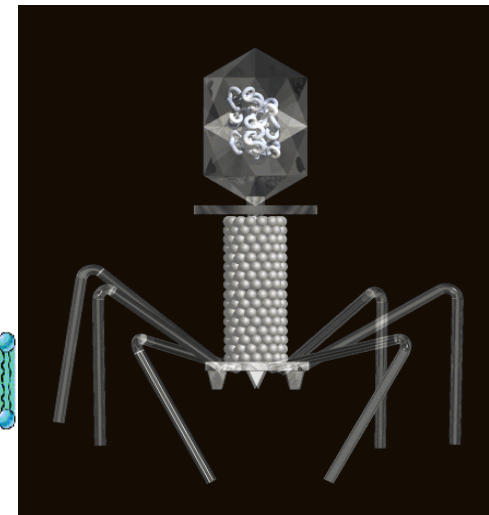
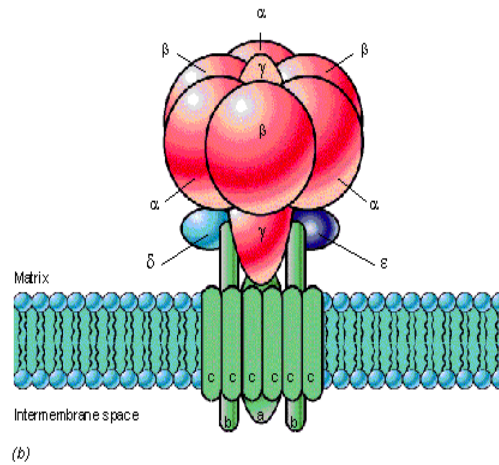
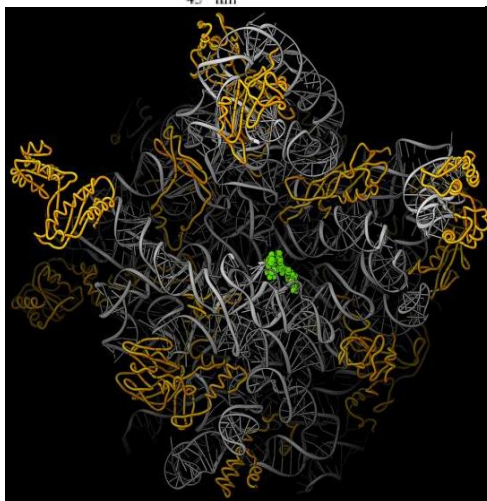
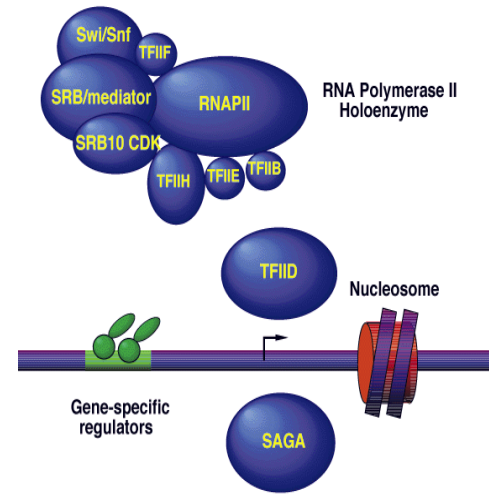
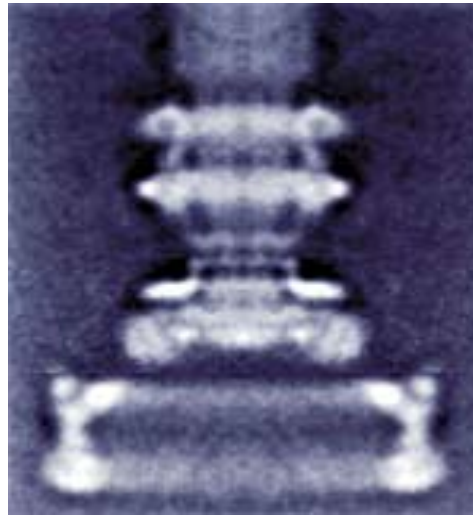
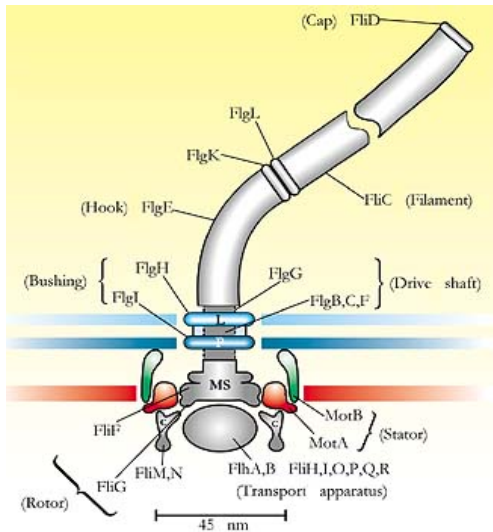

For the Past 10 Years...

- **Scientists have increasingly focused on “signal transduction” and transient protein interactions**
- **New techniques have been developed which reveal which proteins and which parts of proteins are important for interaction**
- **The hope is to get something like this..**



Protein Interaction Tools and Techniques - Experimental Methods

3D Structure Determination*

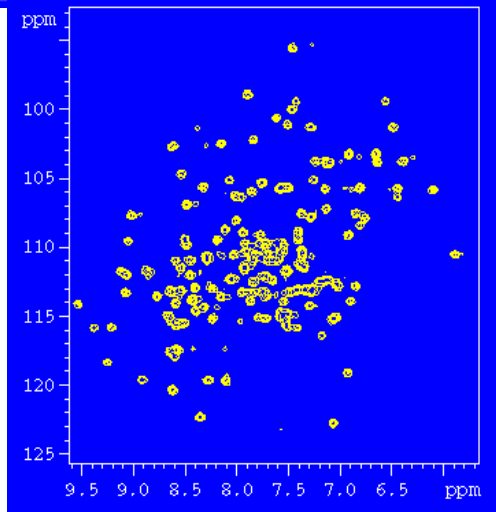
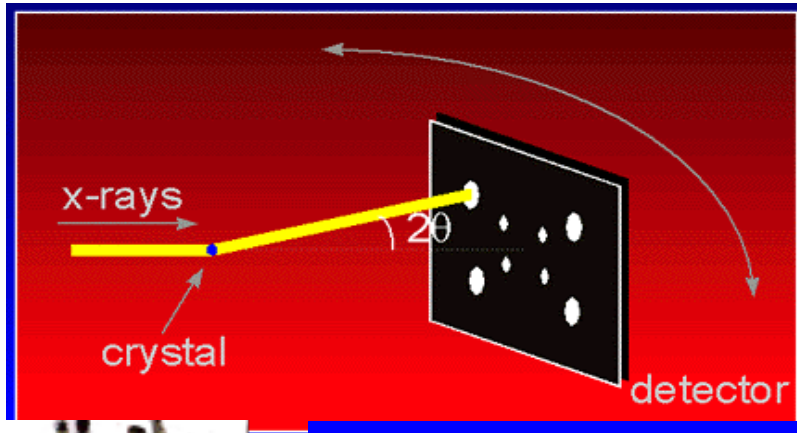

- **X-ray crystallography**
 - grow crystal
 - collect diffract. data
 - calculate e- density
 - trace chain
- **NMR spectroscopy**
 - label protein
 - collect NMR spectra
 - assign spectra & NOEs
 - calculate structure using distance geom.

Quaternary Structure

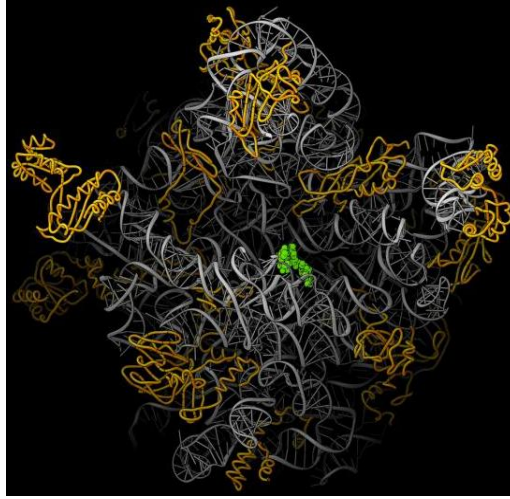
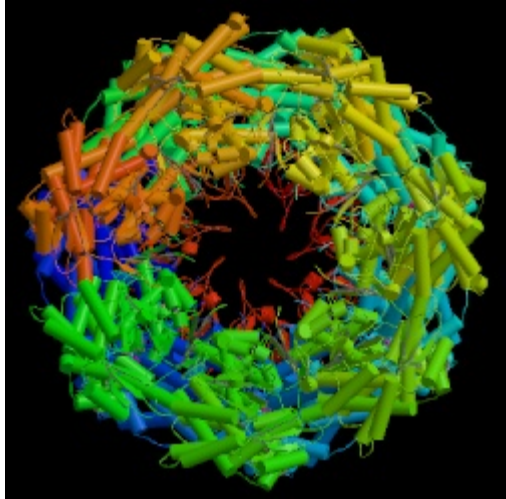

**Some interactions
are real**

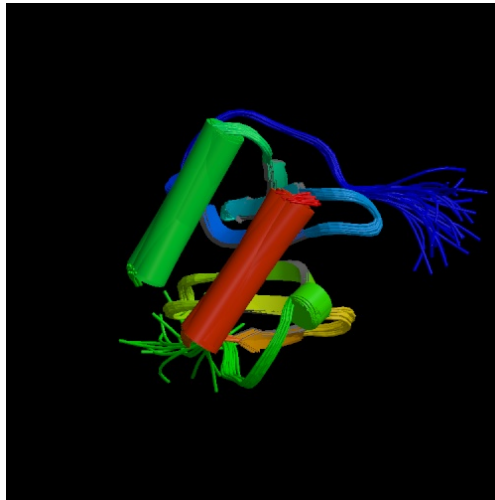
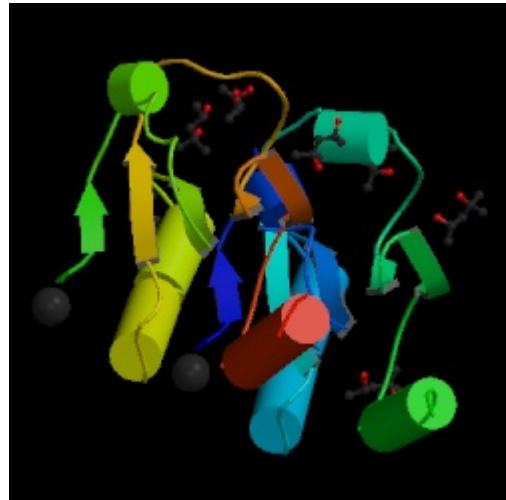

Others are not

Protein Interaction Domains*

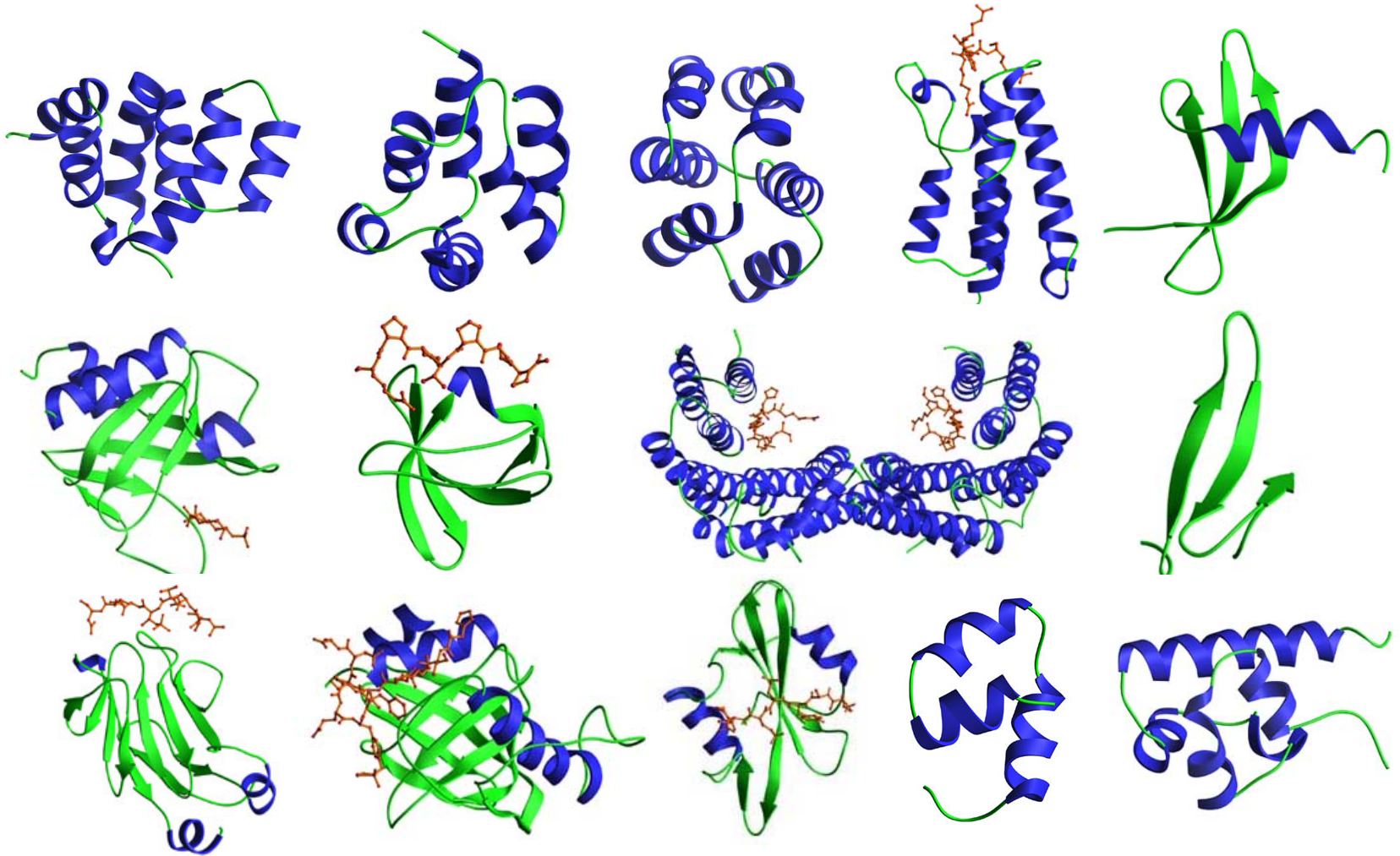

<http://pawsonlab.mshri.on.ca/>

82 domains

Protein Interaction Domains

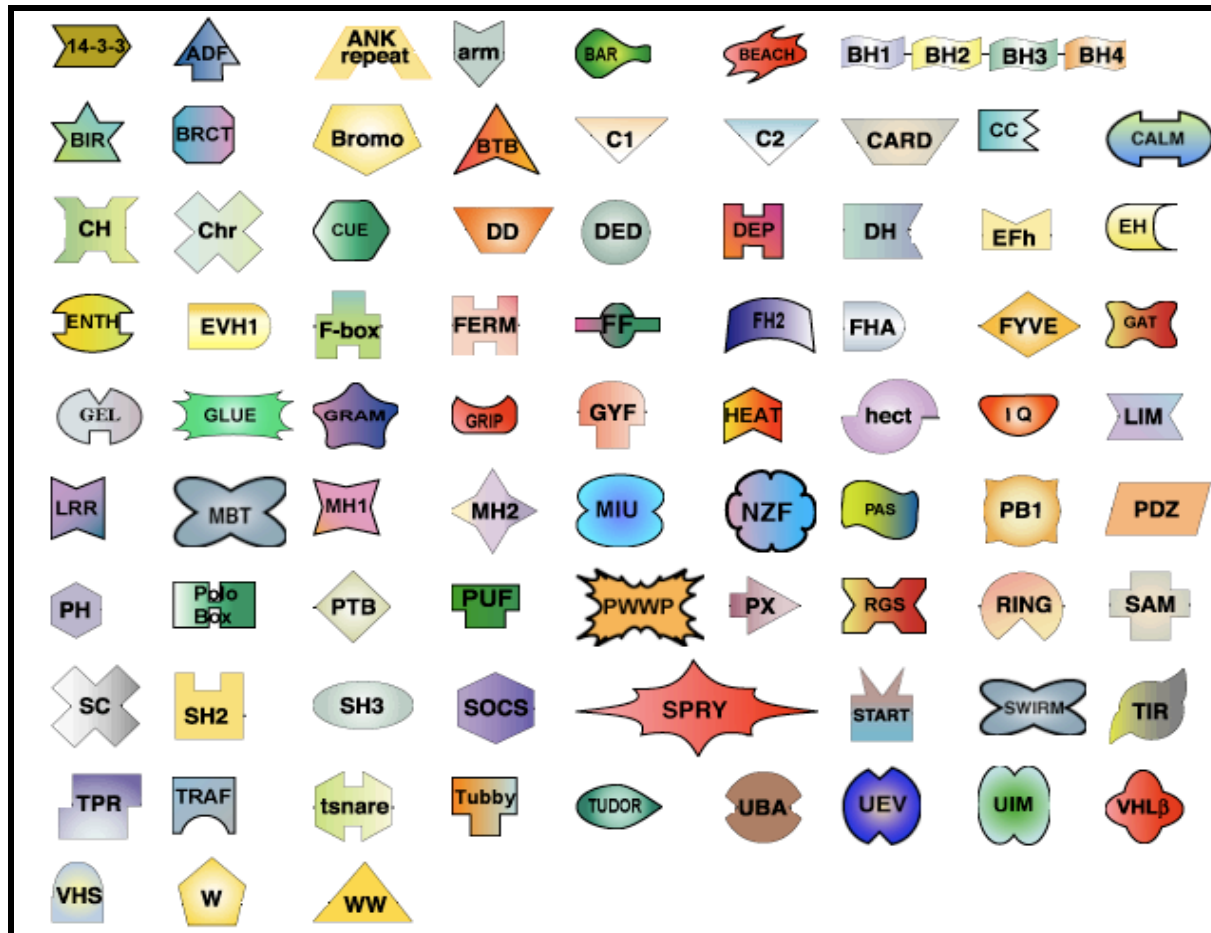

<http://pawsonlab.mshri.on.ca/>

Yeast Two-Hybrid Analysis*

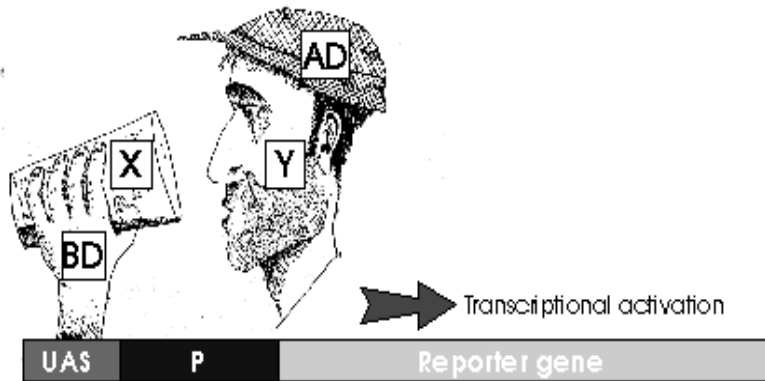
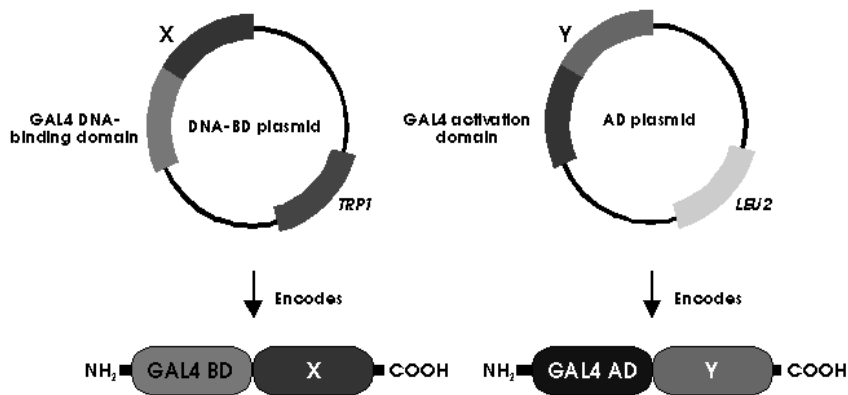

- Yeast two-hybrid experiments yield information on protein protein interactions
- GAL4 Binding Domain
- GAL4 Activation Domain
- X and Y are two proteins of interest
- If X & Y interact then reporter gene is expressed

In Vitro Yeast 2-Hybrid

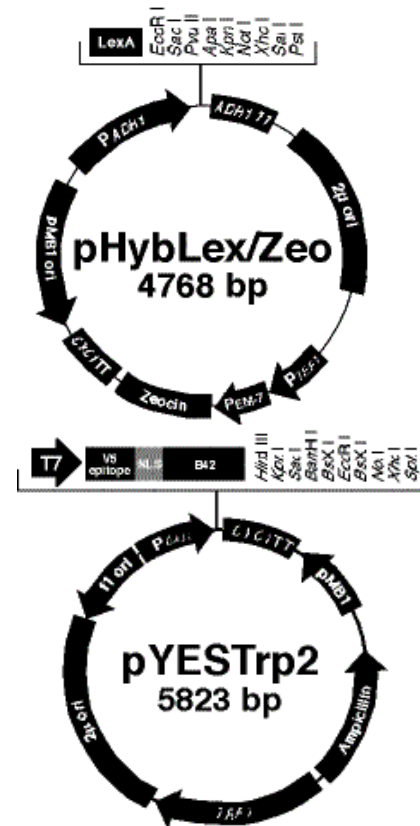
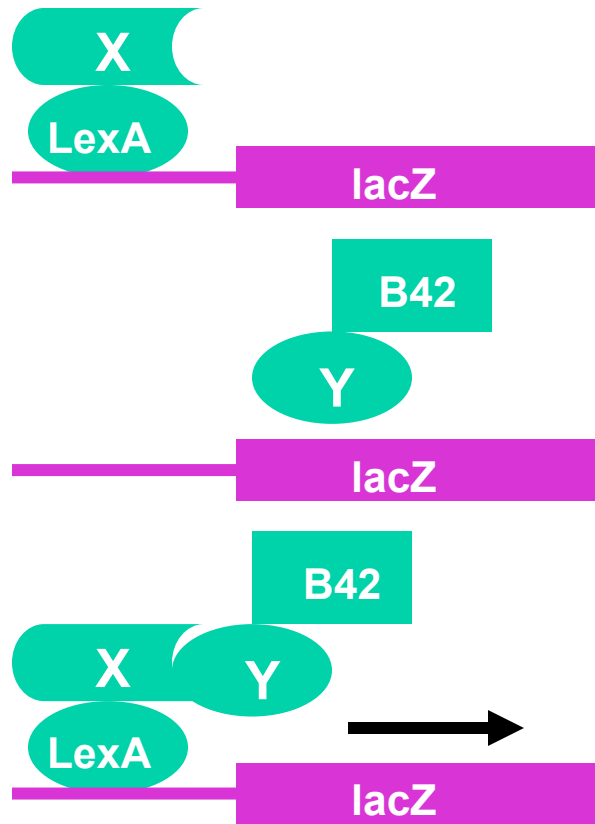

Example of 2-Hybrid Analysis*

- Uetz P. et al., “*A Comprehensive Analysis of Protein-Protein Interactions in Saccharomyces cerevisiae*” **Nature** 403:623-627 (2000)
- High Throughput Yeast 2 Hybrid Analysis
- 957 putative interactions
- 1004 of 6000 predicted proteins involved

Example of 2-Hybrid Analysis

- Rain JC. et al., “*The protein-protein interaction map of Helicobacter pylori*”
Nature 409:211-215 (2001)
- High Throughput Yeast 2 Hybrid Analysis
- 261 H. pylori proteins scanned against genome
- >1200 putative interactions identified
- Connects >45% of the H. pylori proteome

Another Way?*

- Ho Y, Gruhler A, et al. *Systematic identification of protein complexes in Saccharomyces cerevisiae by mass spectrometry*. Nature 415:180-183 (2002)
- High Throughput Mass Spectral Protein Complex Identification (HMS-PCI)
- 10% of yeast proteins used as “bait”
- 3617 associated proteins identified
- 3 fold higher sensitivity than yeast 2-hybrid

Affinity Pull-down*

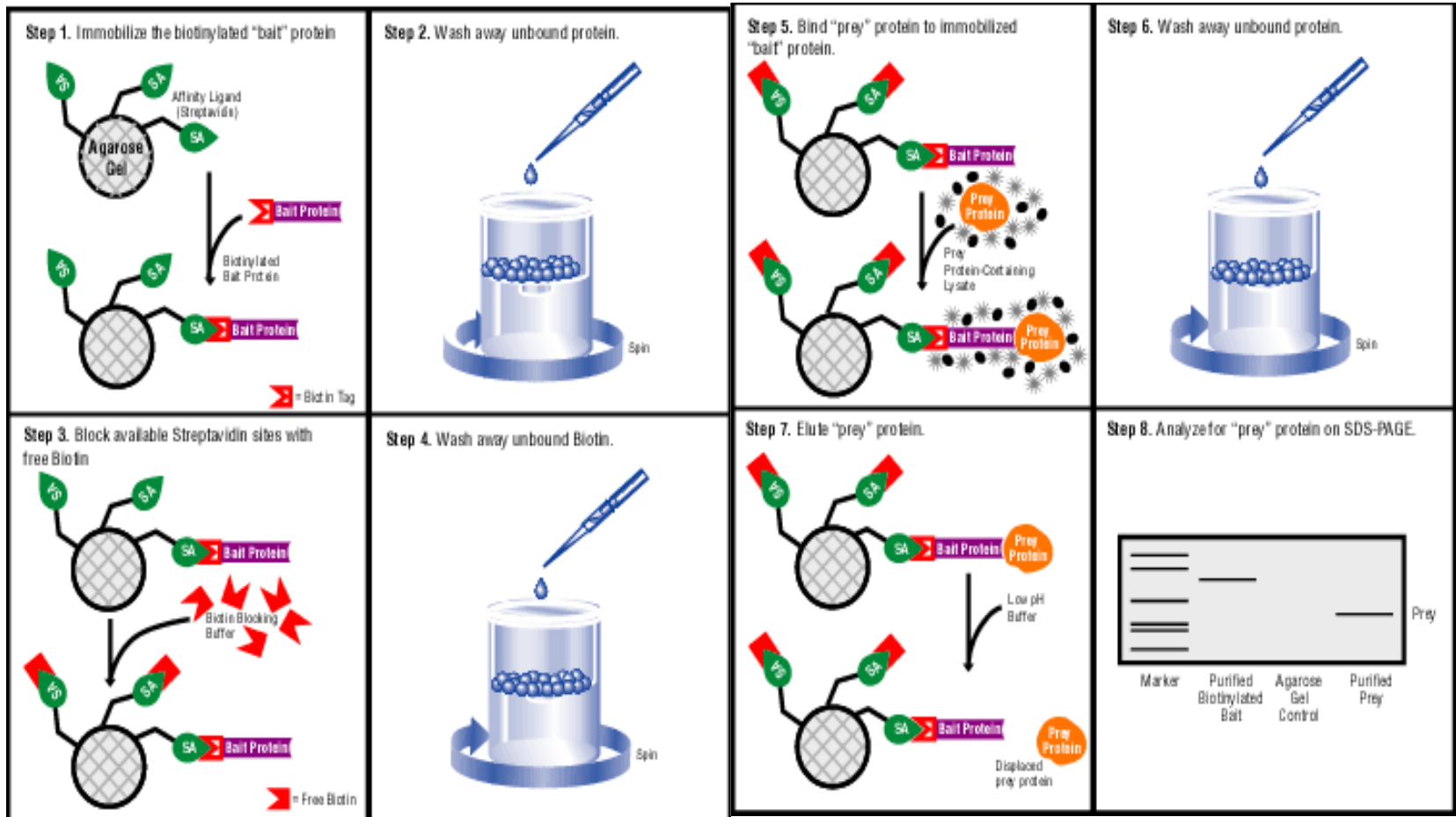

HMS-PCI*

FLAG-tagged protein complex

↓
immunoaffinity capture

↓
gel separation

↓
excise band/trypsin digest

↓
LC-MS/MS fragmentation

↓
database searches

↓
raw hits

↓
filtered dataset

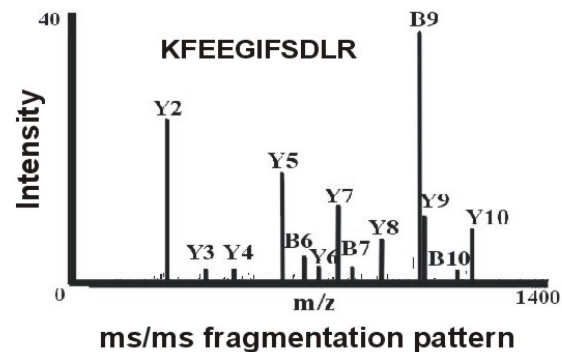
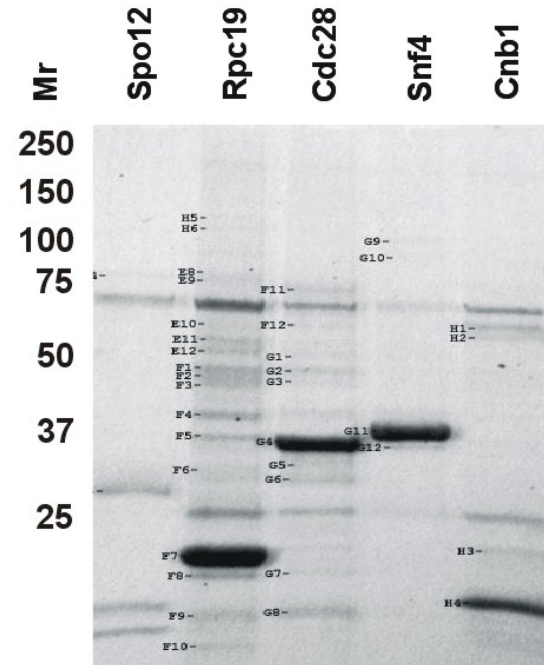

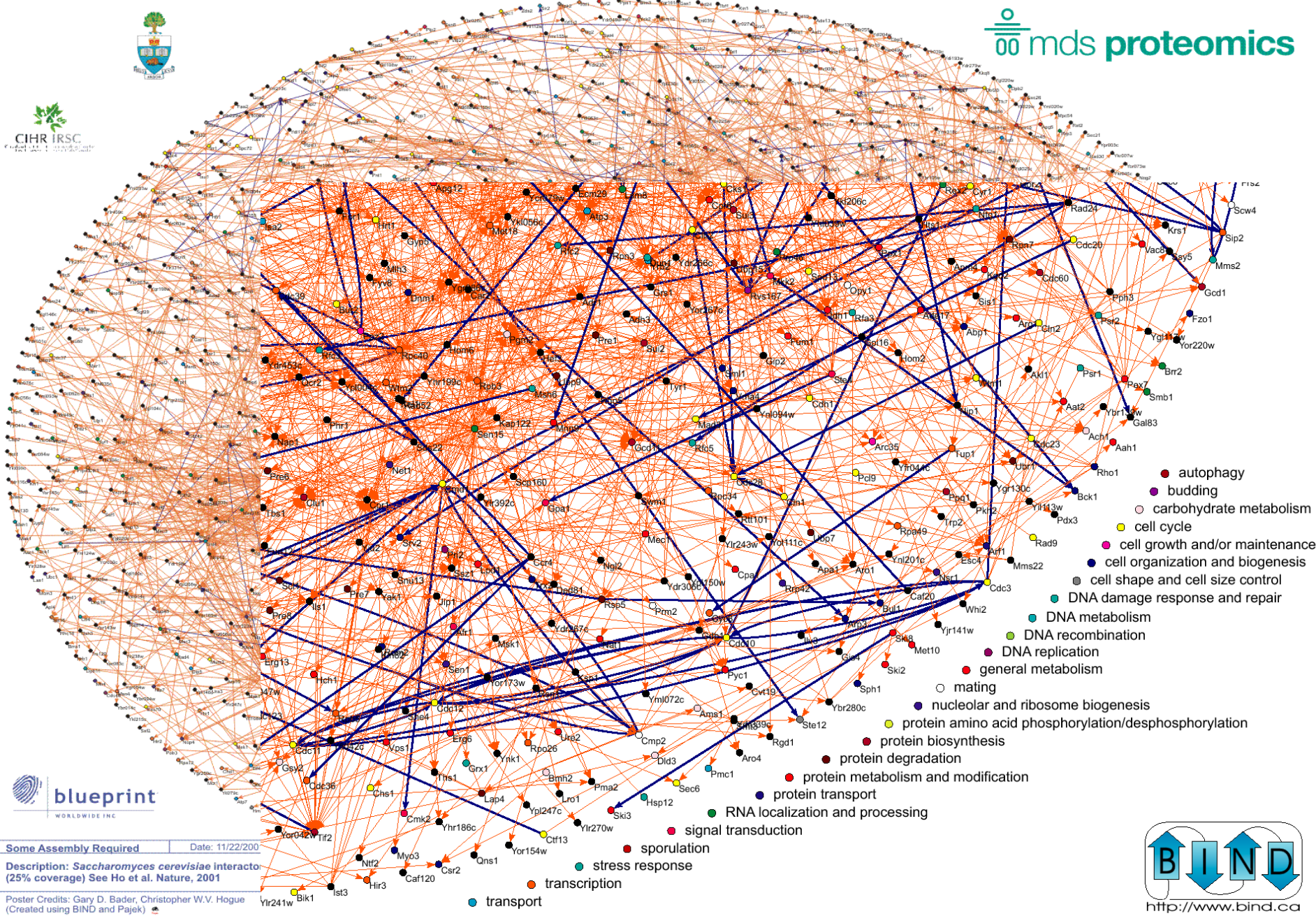

- autophagy
- budding
- carbohydrate metabolism
- cell cycle
- cell growth and/or maintenance
- cell organization and biogenesis
- cell shape and cell size control
- DNA damage response and repair
- DNA metabolism
- DNA recombination
- DNA replication
- general metabolism
- mating
- nucleolar and ribosome biogenesis
- protein amino acid phosphorylation/desphosphorylation
- protein biosynthesis
- protein degradation
- protein metabolism and modification
- protein transport
- RNA localization and processing
- signal transduction
- sporulation
- stress response
- transcription
- transport

Some Assembly Required | Date: 11/22/2000
 Description: *Saccharomyces cerevisiae* interactome (25% coverage) See Ho et al. Nature, 2001
 Poster Credits: Gary D. Bader, Christopher W.V. Hogue (Created using BIND and Pajek)



Synthetic Genetic Interactions*

- **Two mutations are synthetically lethal if cells with either of the single mutations are viable but cells with both mutations are non-viable**
- **Two types of synthetic lethal genetic interactions (lethal, slow growth)**
- **Mate two mutants without phenotypes to get a daughter cell with a phenotype**
- **Genetic interactions provide functional data on protein interactions or redundant genes**
- **About 23% of known SLs (1295 - YPD+MIPS) are known protein interactions in yeast**

Synthetic Lethality*

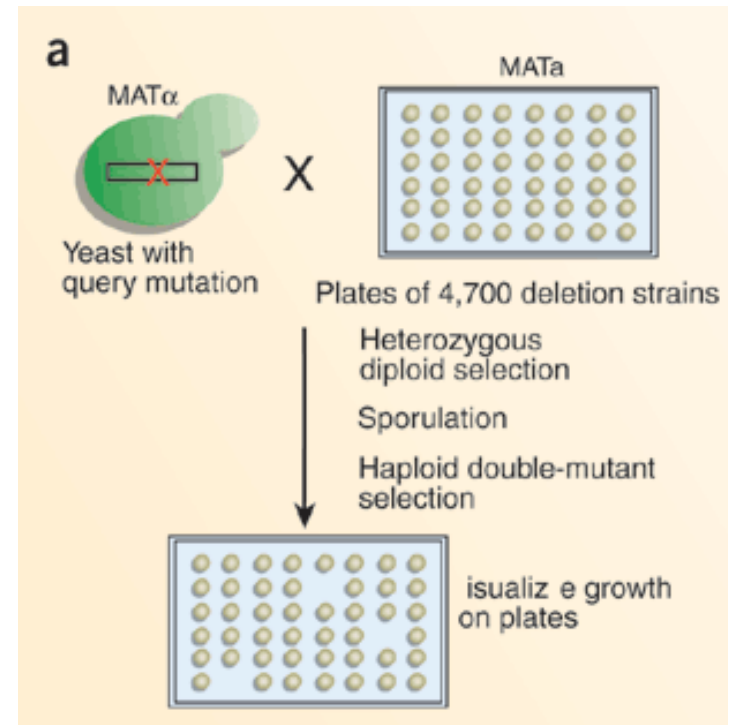
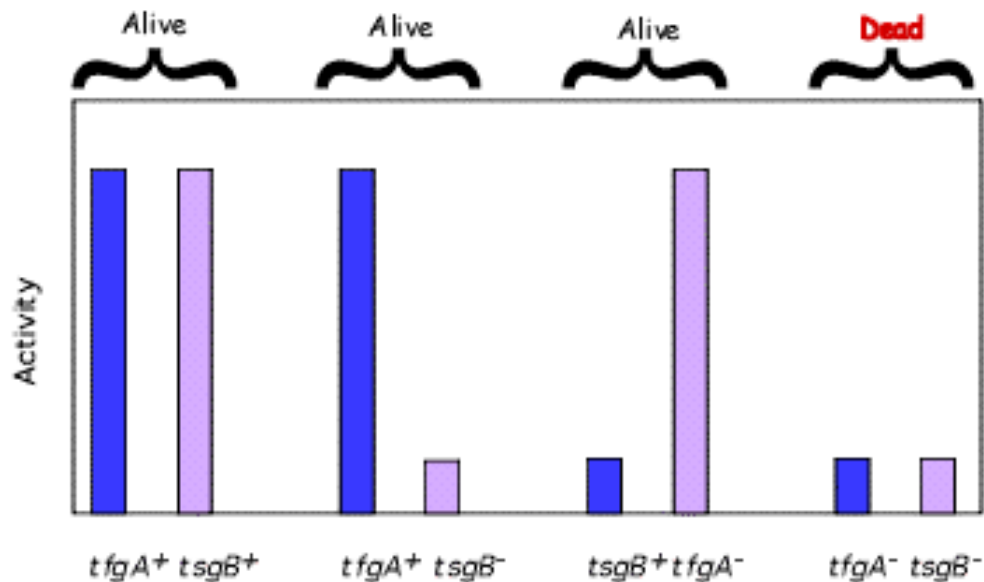

Synthetic Genetic Interactions in Yeast

- Cell Polarity
- Cell Wall Maintenance
- Cell Structure
- Mitosis
- Chromosome Structure
- DNA Synthesis
- DNA Repair
- Unknown
- Others

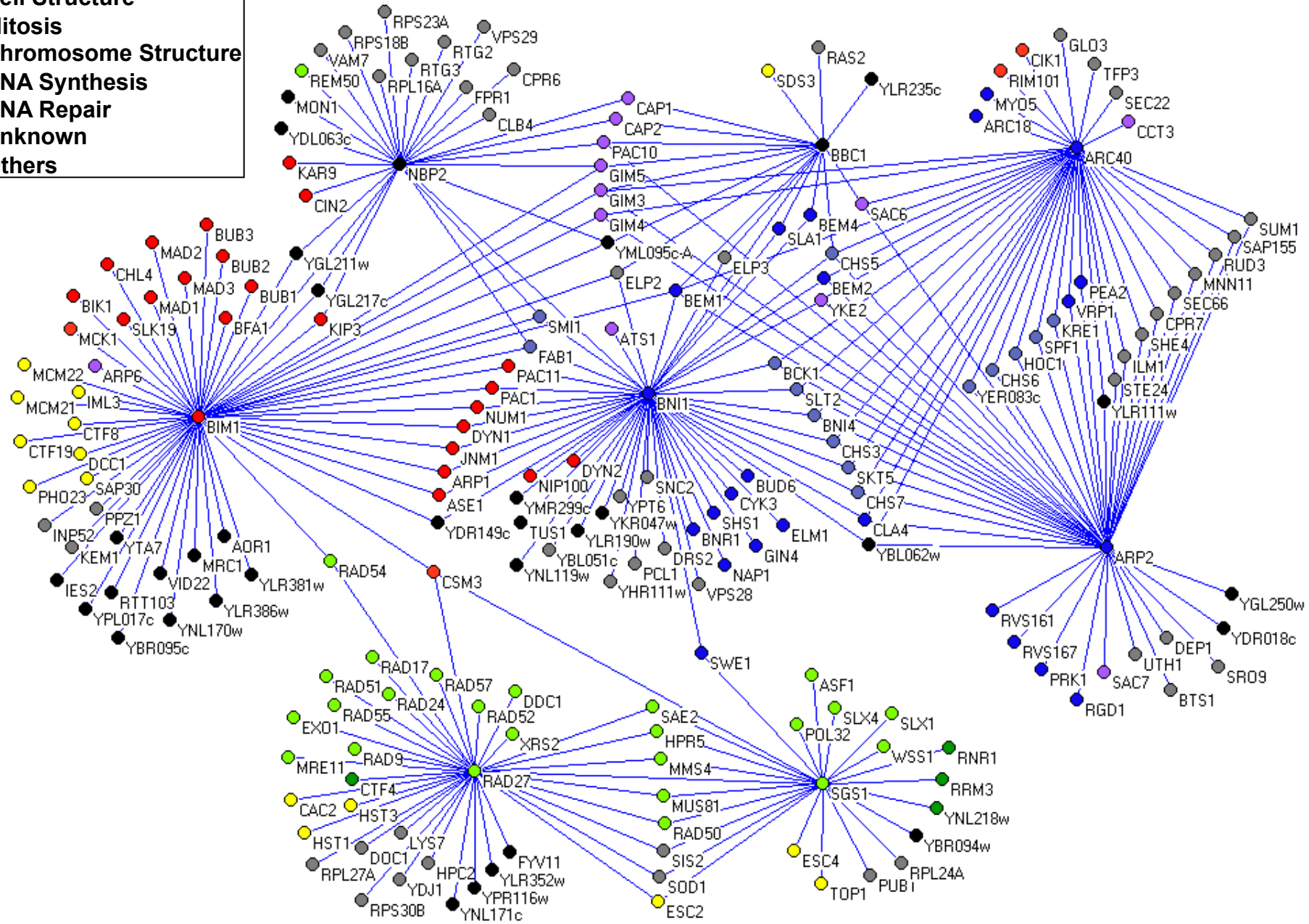

Protein Chips*

Antibody Array

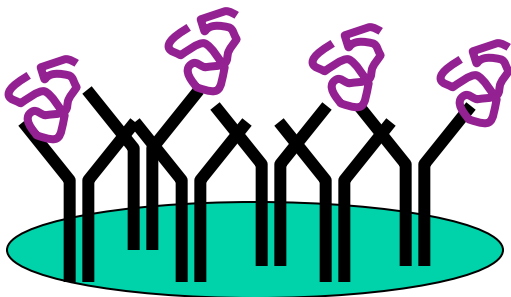

Antigen Array

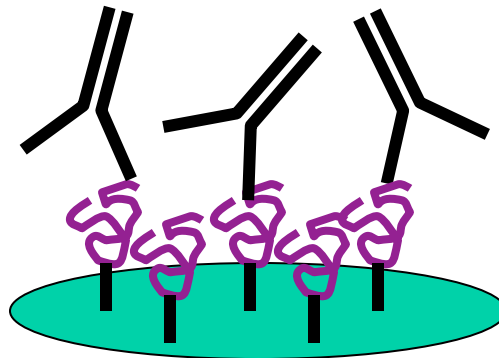

Ligand Array

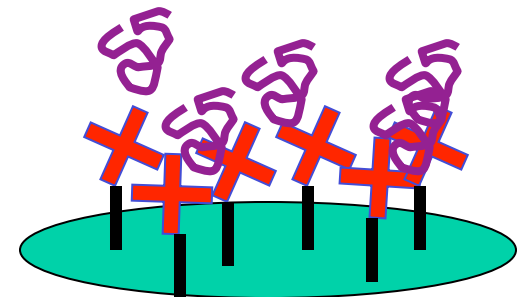

Detection by: SELDI MS, fluorescence, SPR, electrochemical, radioactivity, microcantelever

Protein (Antigen) Chips

H Zhu, J Klemic, S Chang, P Bertone, A Casamayor, K Klemic, D Smith, M Gerstein, M Reed, & M Snyder (2000). **Analysis of yeast protein kinases using protein chips**. Nature Genetics 26: 283-289

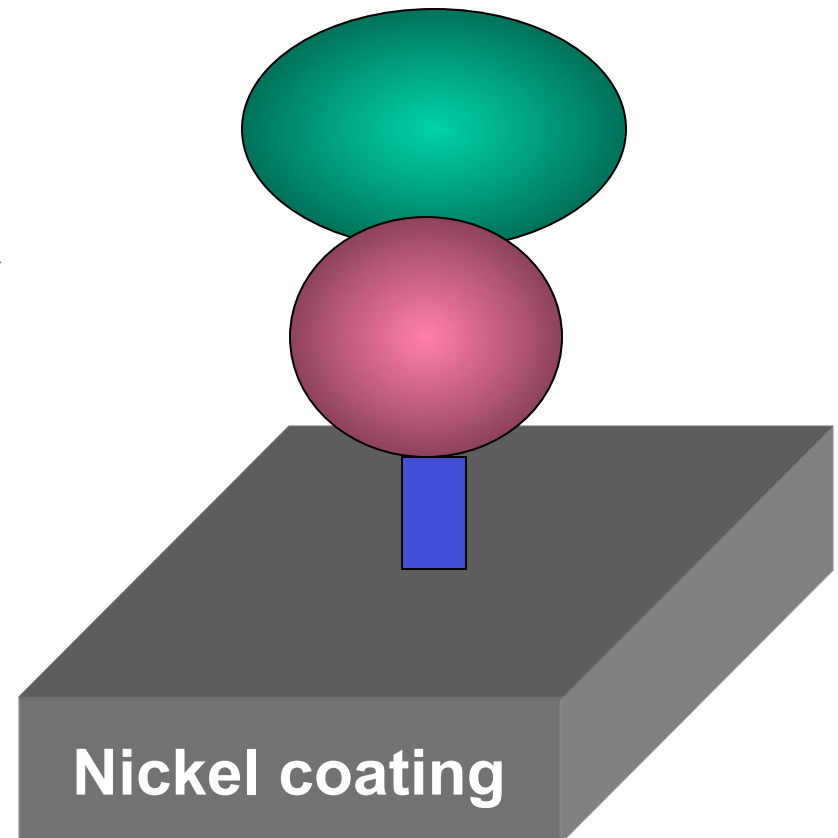
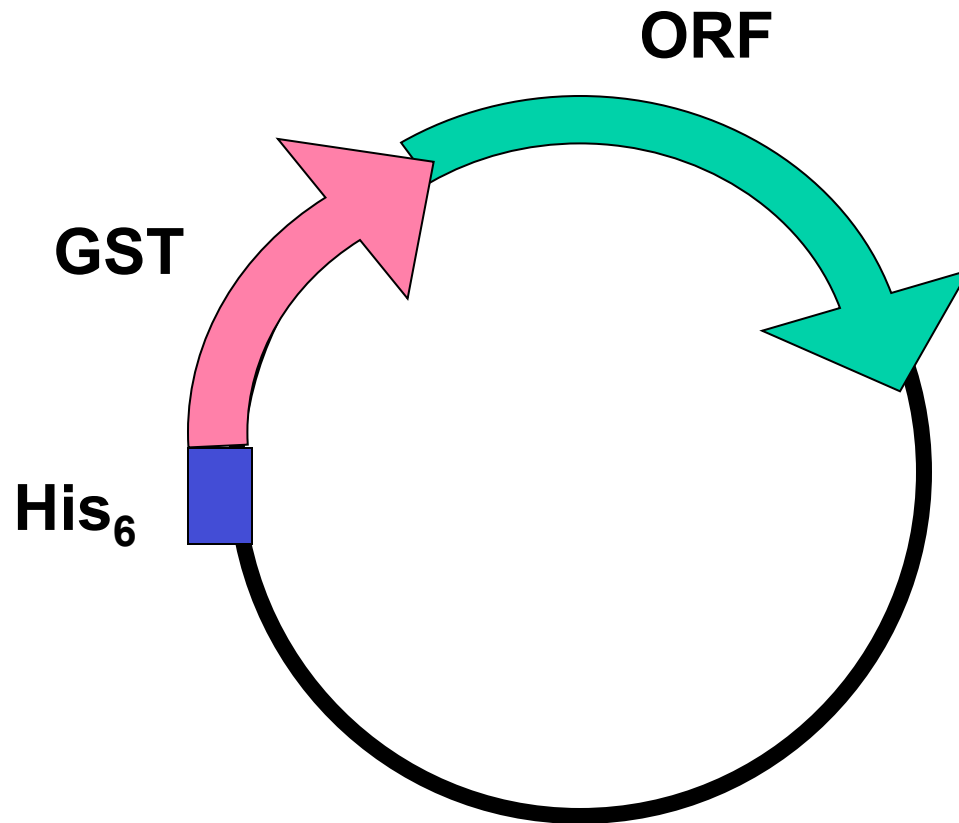

Protein (Antigen) Chips

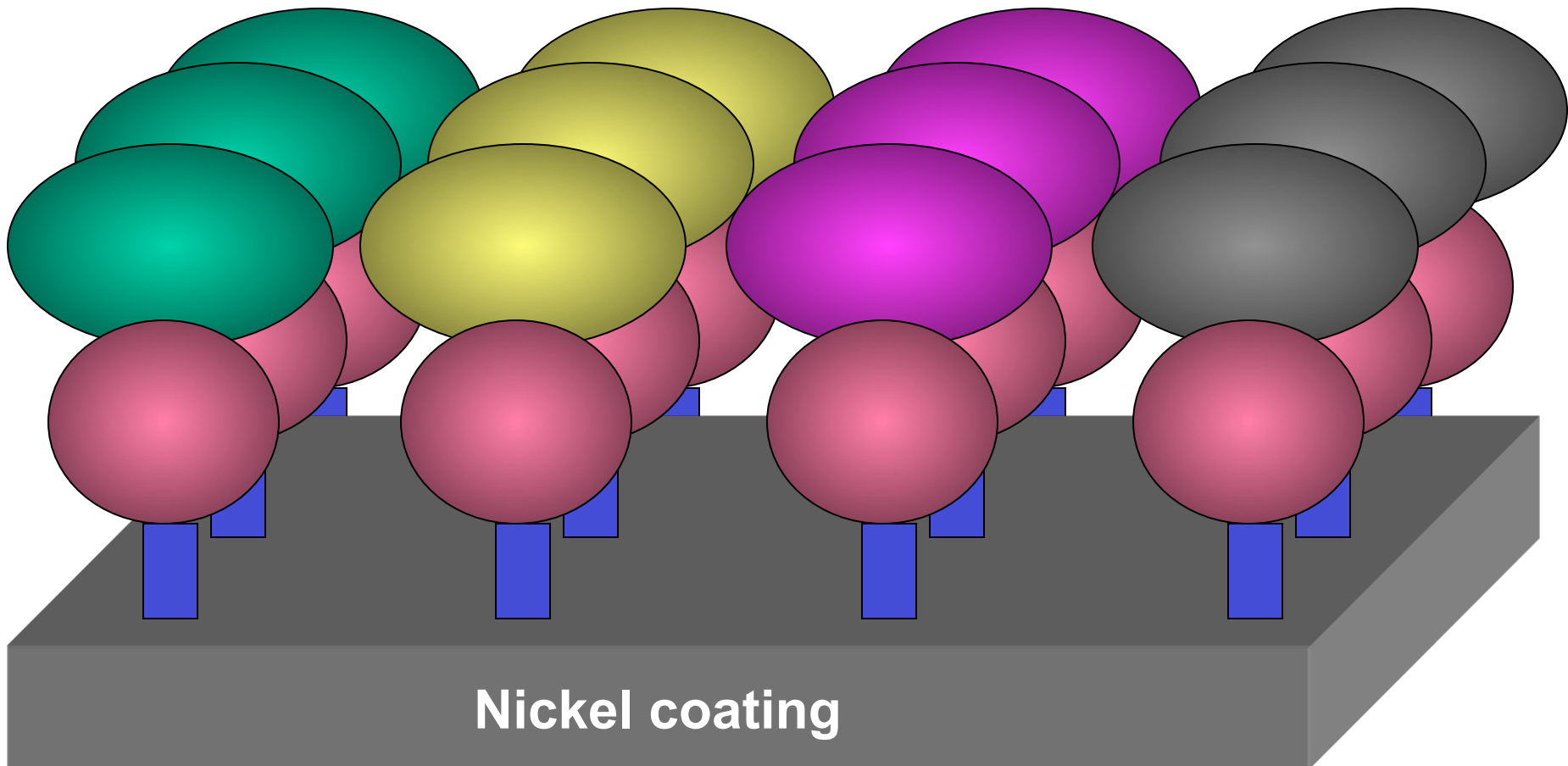

Arraying Process

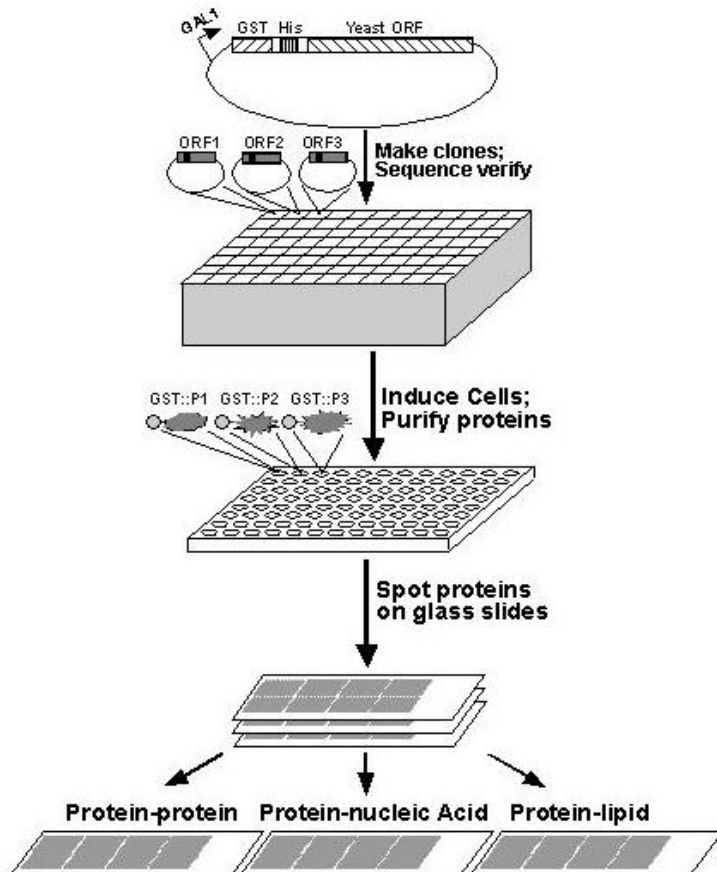

Probe with anti-GST Mab

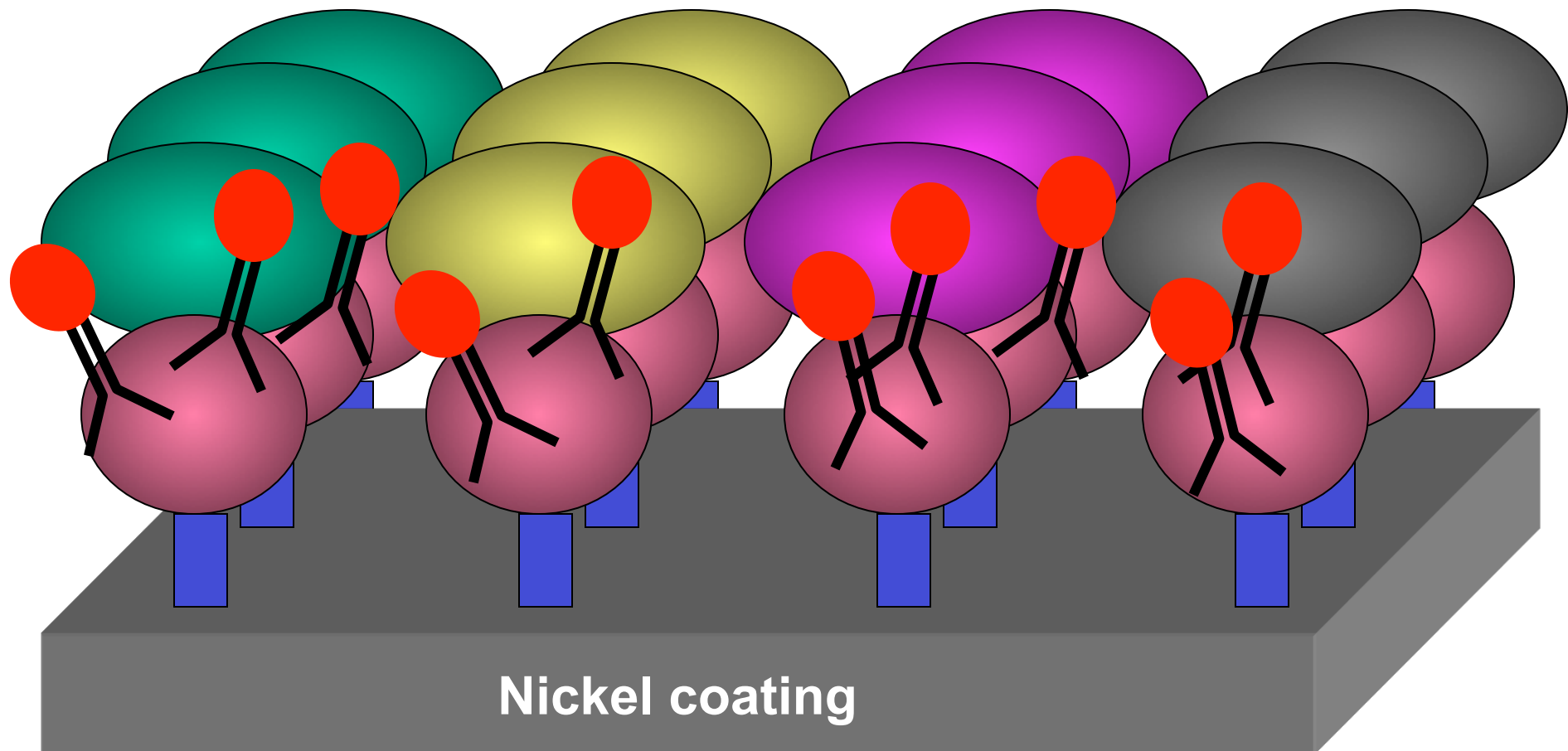

Anti-GST Probe

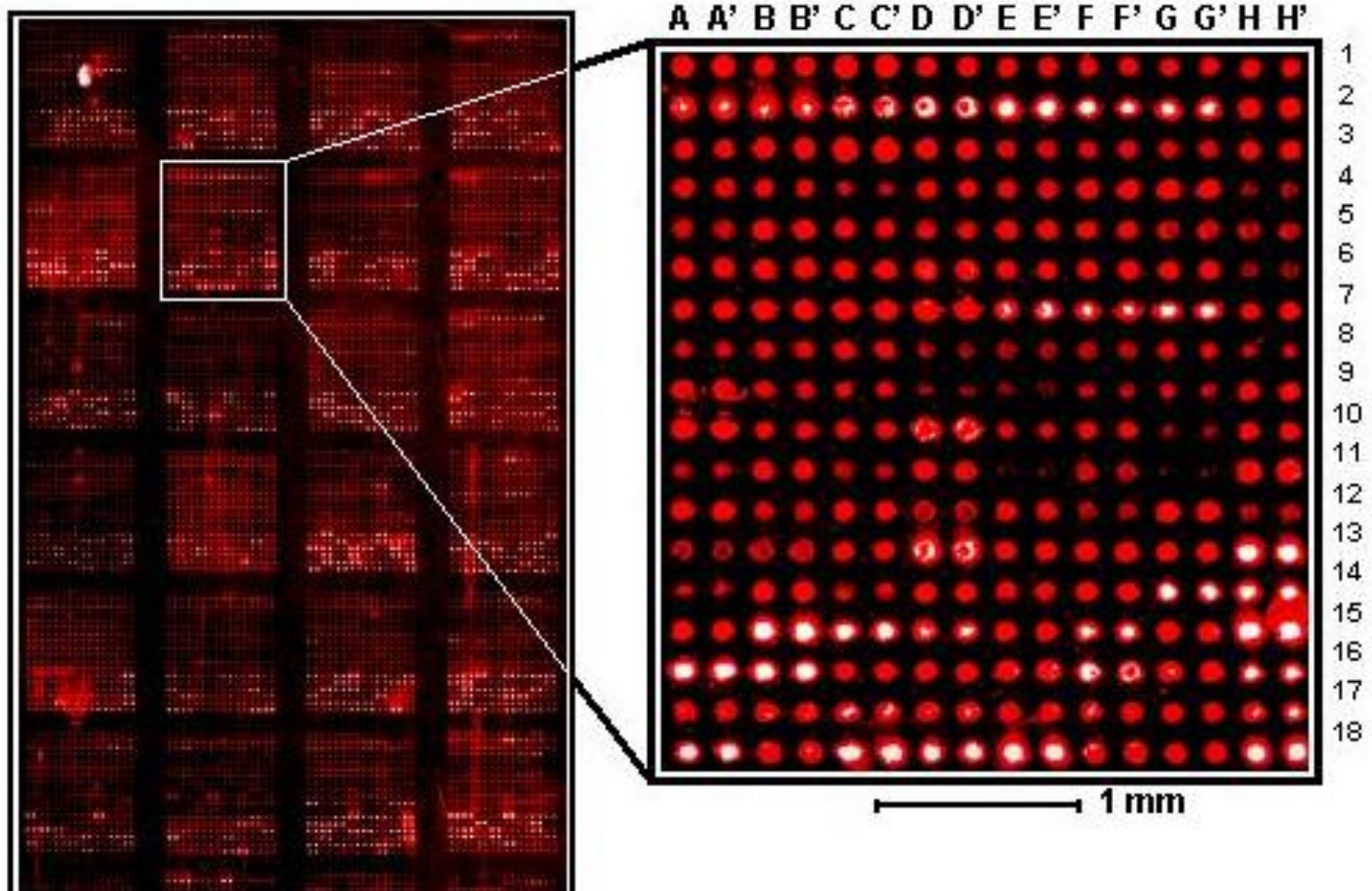

Probe with Cy3-labeled Calmodulin

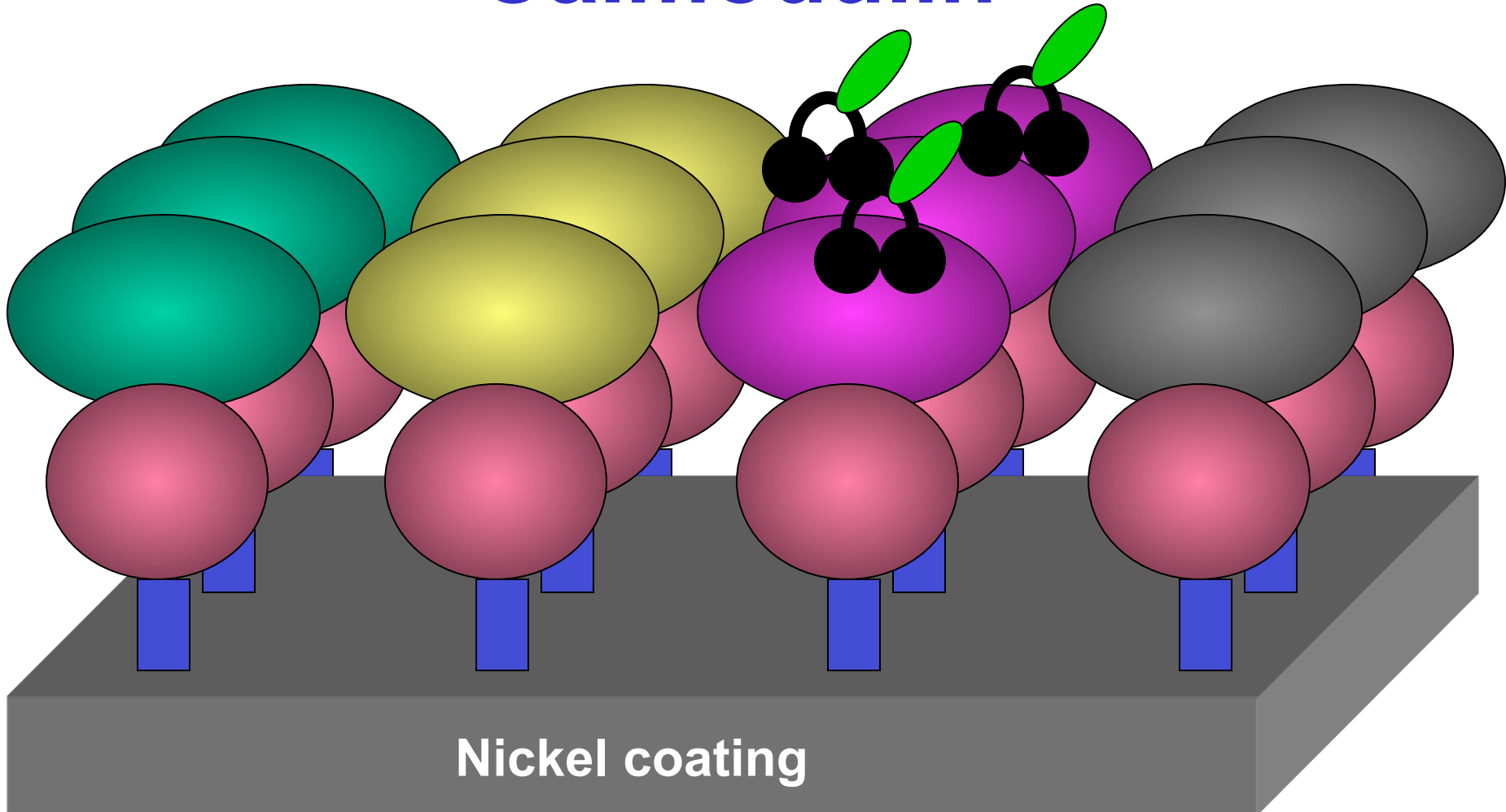

“Functional” Protein Array*

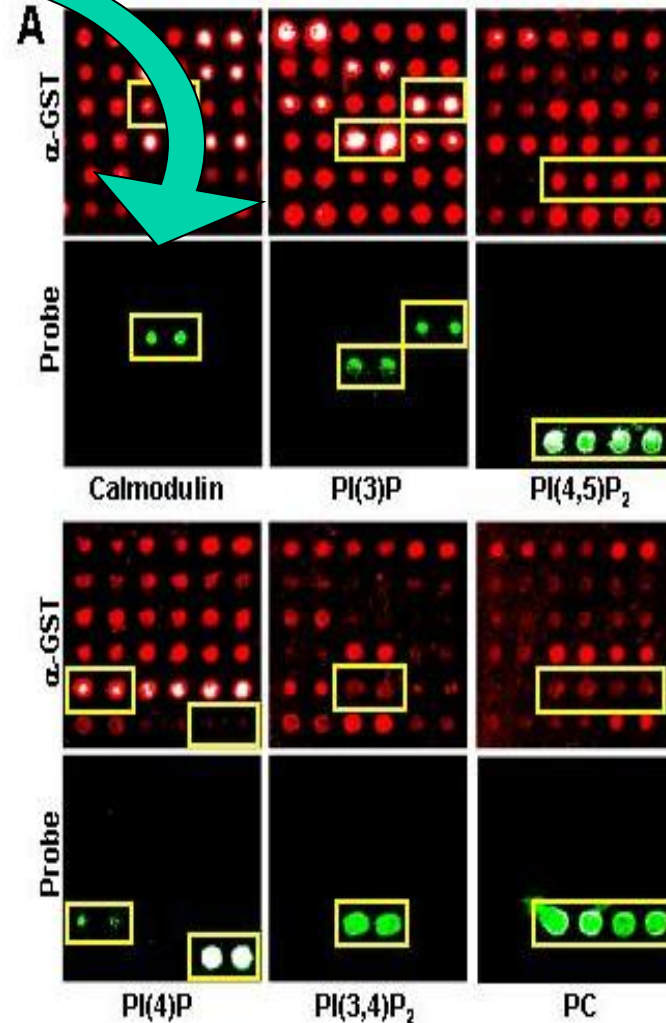
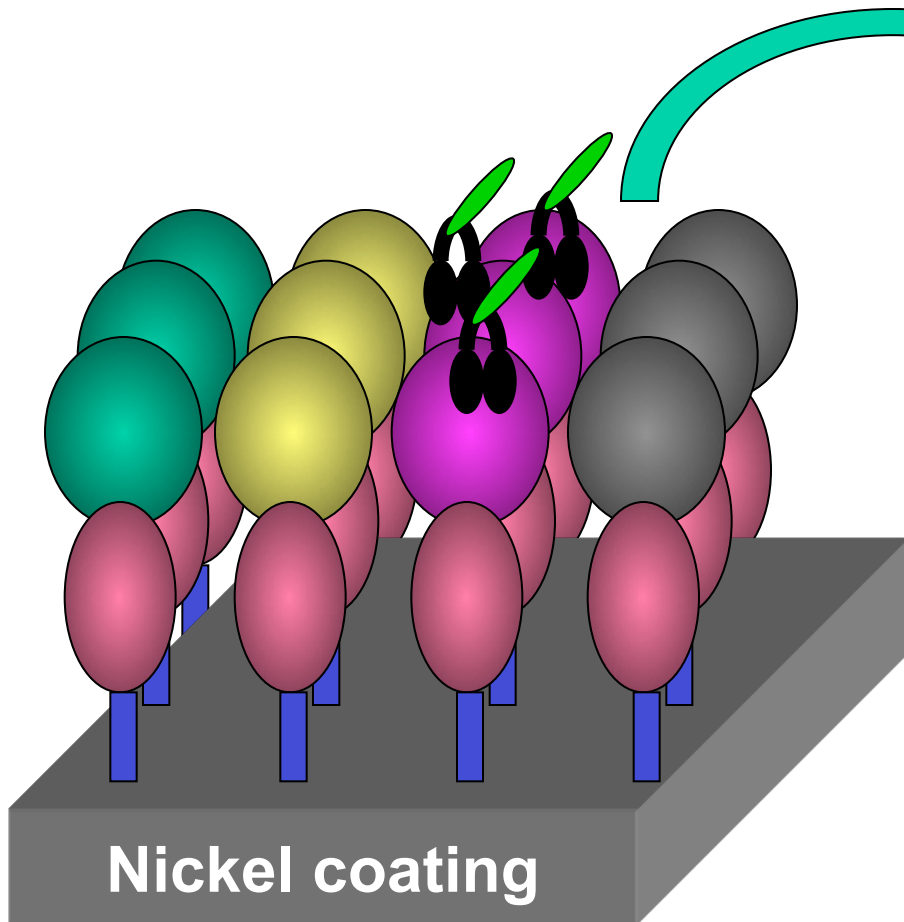

Antigen Array (ELISA Chip)*

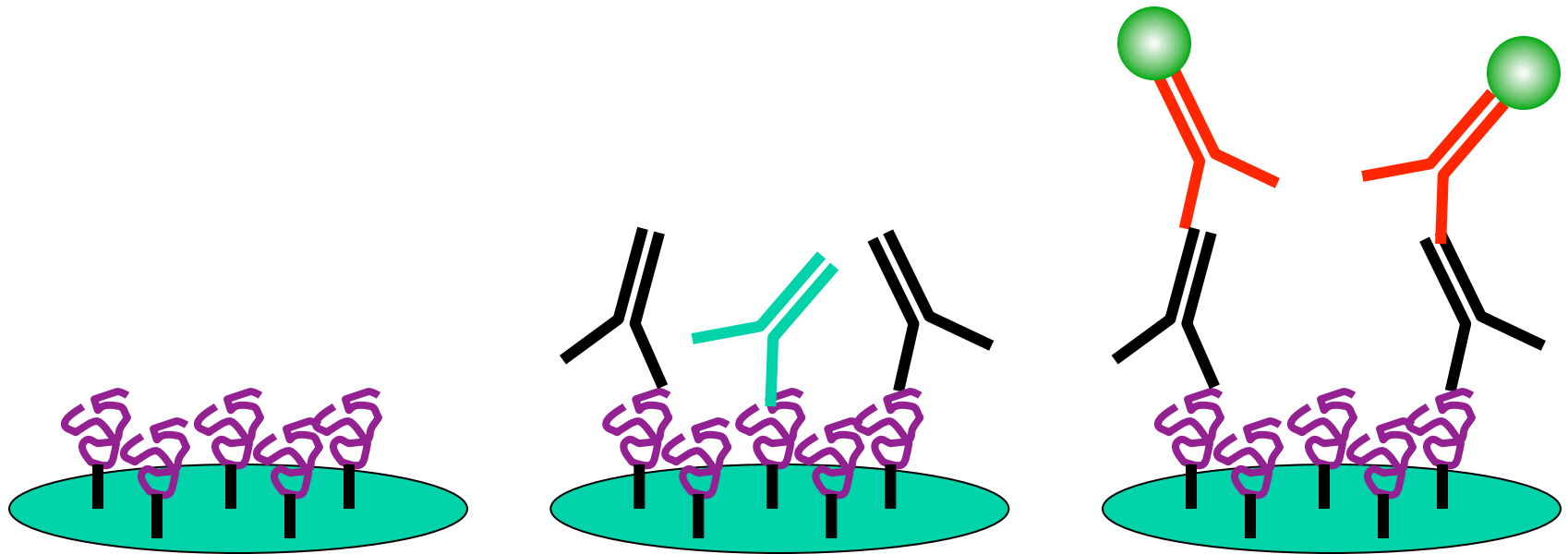

Mezzasoma et al. *Clinical Chem.* 48:121 (2002)

Diagnostic Antigen Array

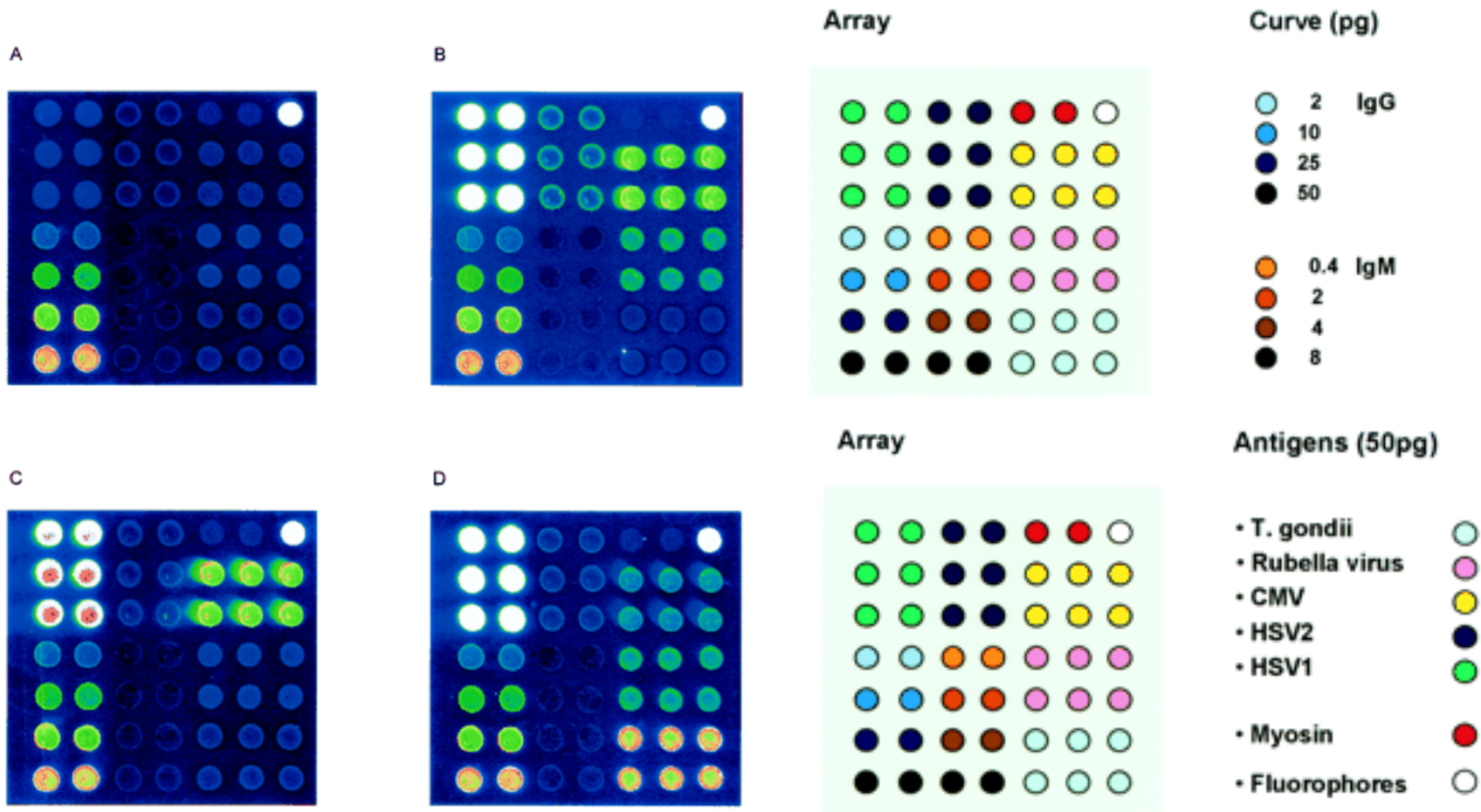

Protein Chips

Antibody Array

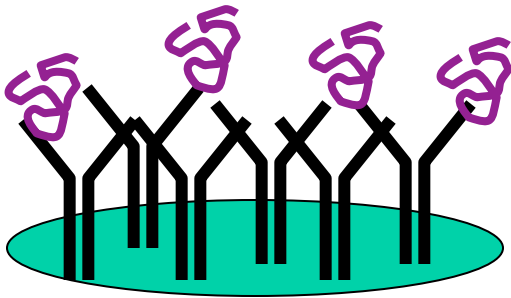

Antigen Array

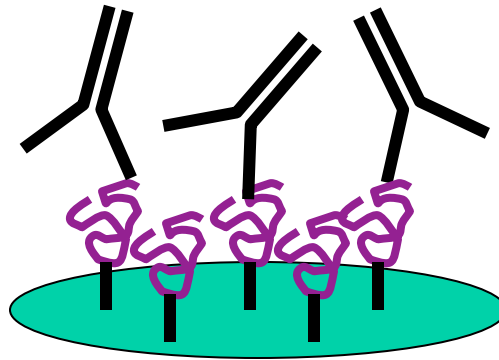

Ligand Array

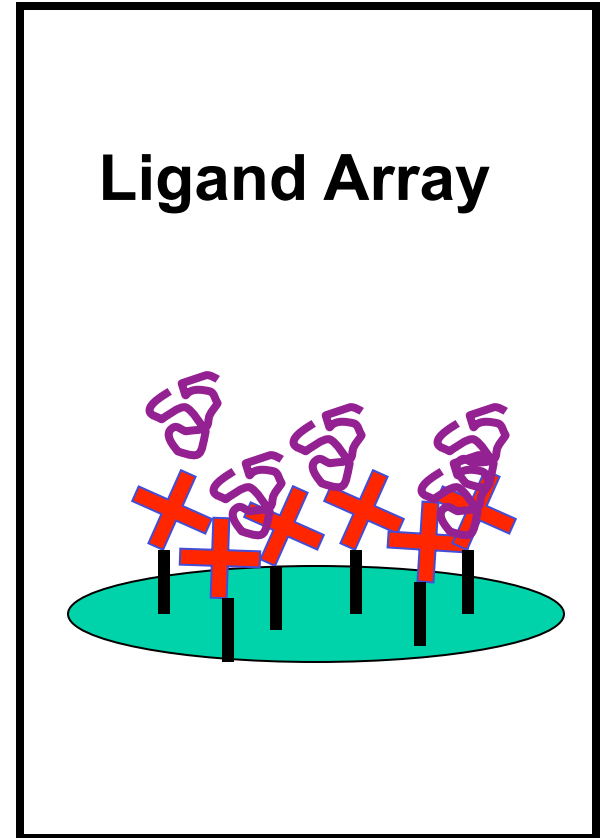

Ciphergen “Ligand” Chips*



- **Hydrophobic (C₈) Arrays**
- **Hydrophilic (SiO₂) Arrays**
- **Anion exchange Arrays**
- **Cation exchange Arrays**
- **Immobilized Metal Affinity (NTA-nitroloacetic acid) Arrays**
- **Epoxy Surface (amine and thiol binding) Arrays**

Ciphergen (BioRad) ProteinChip*

SELDI ProteinChip™ Arrays for Proteomics

- Sample goes *directly* onto the ProteinChip™ Array
- Proteins ● are captured, *retained* and purified *directly* on the chip (affinity capture )
- Retentate map is "read" by Surface-Enhanced Laser Desorption/Ionization (SELDI)
- Retained proteins are processed directly on the chip

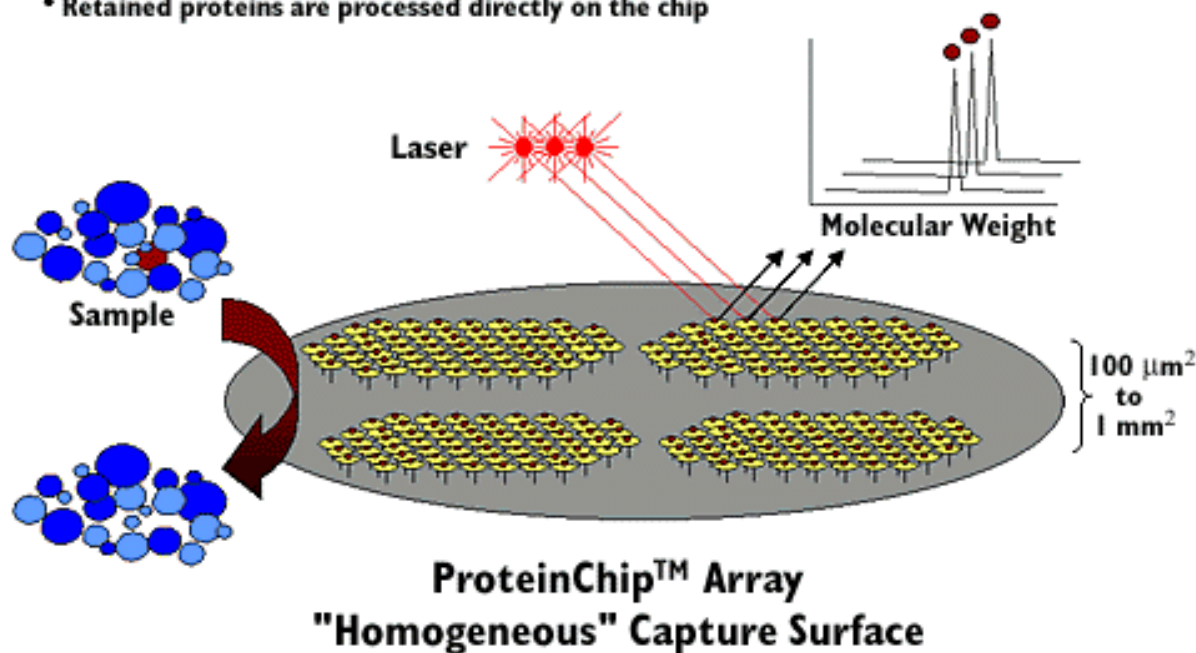

Peptide/Protein Profile

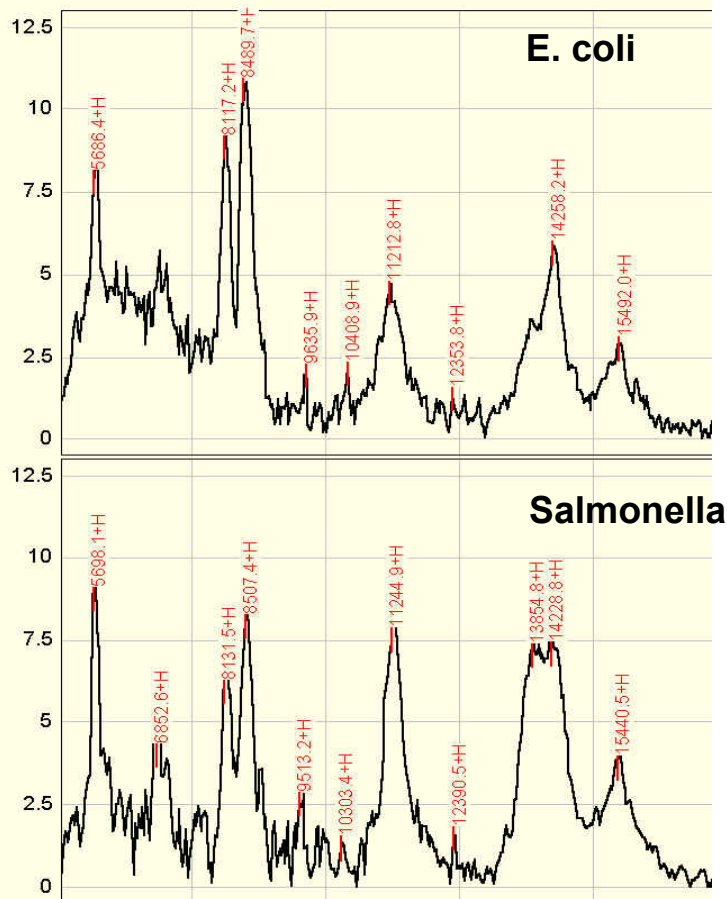

Protein Interaction Tools and Techniques - Computational Methods

Sequence Searching Against Known Domains*

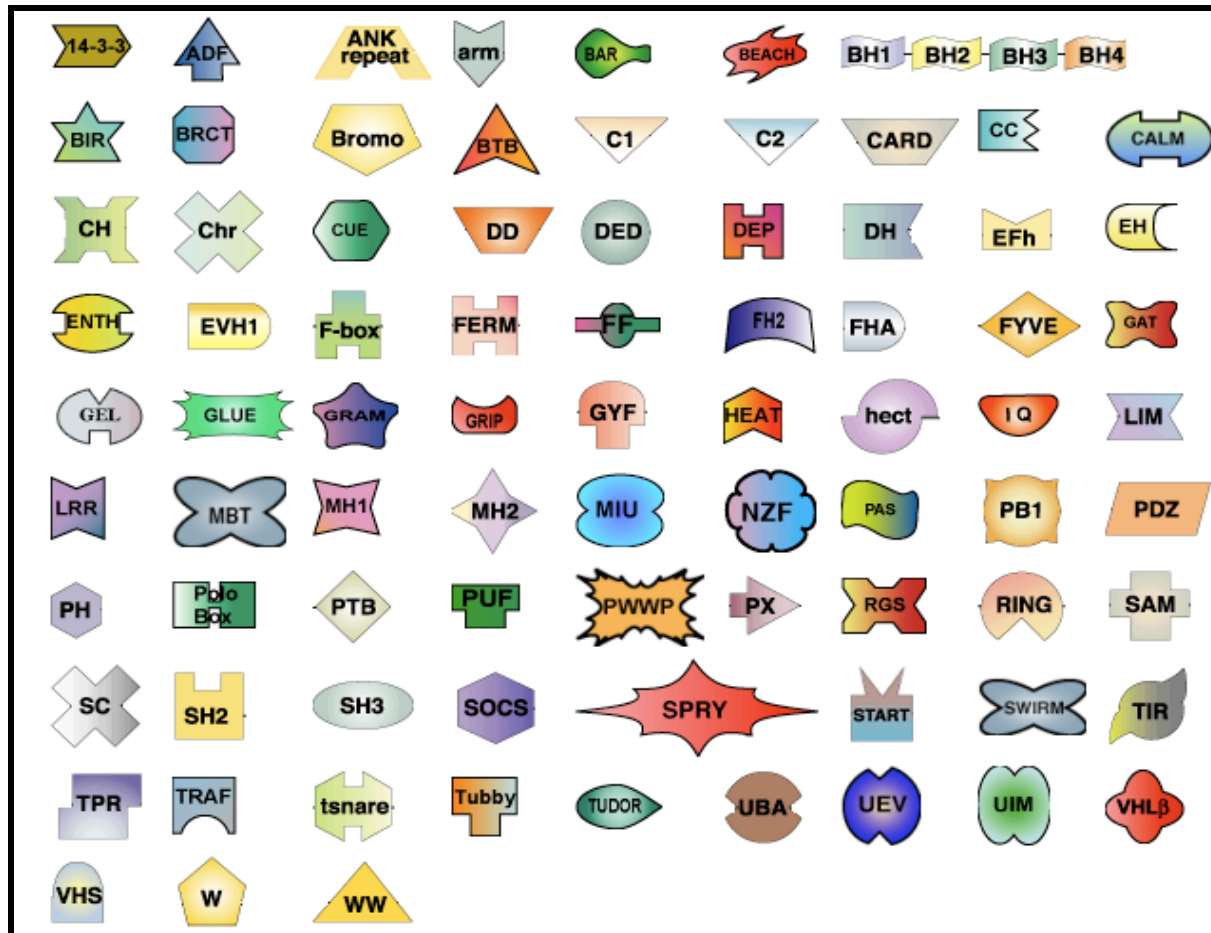

<http://pawsonlab.mshri.on.ca/>

Motif Searching Using Known Motifs

Protein Interaction Domains

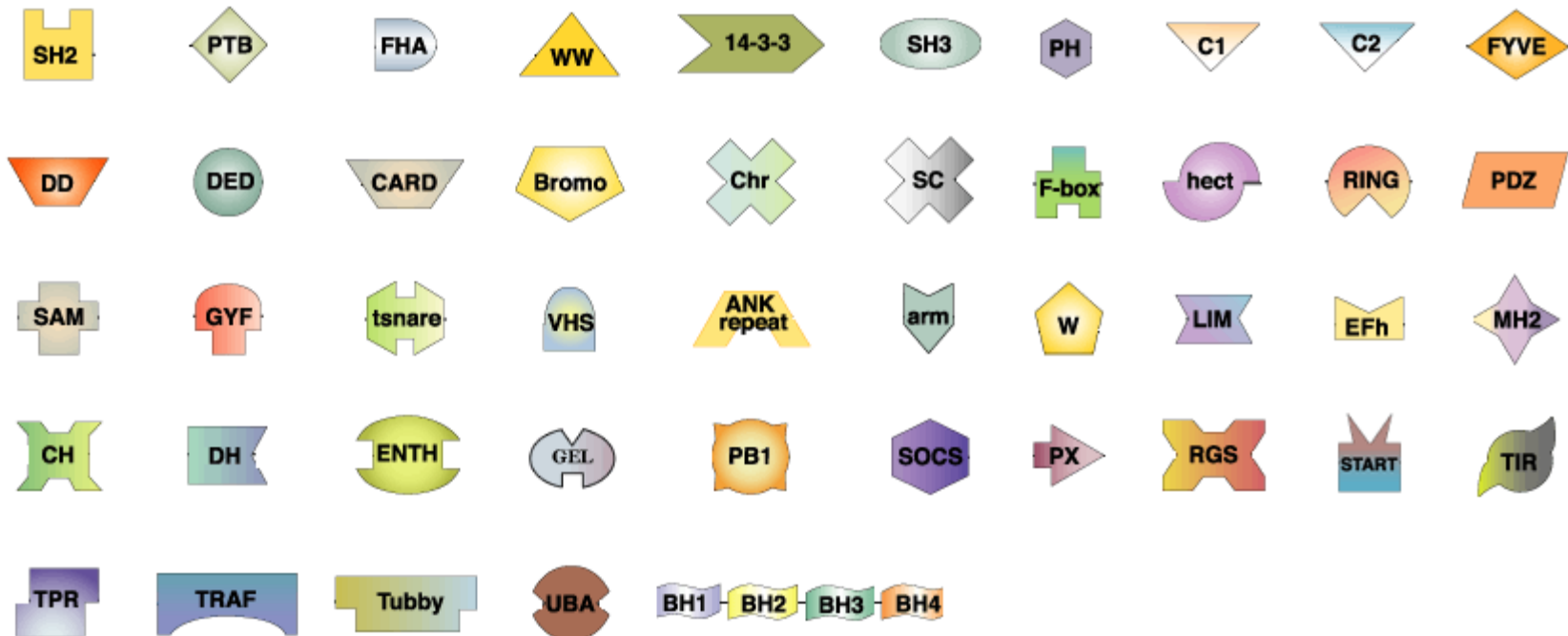

Text Mining*

- **Searching Medline or Pubmed for words or word combinations**
- **“X binds to Y”; “X interacts with Y”; “X associates with Y” etc. etc.**
- **Requires a list of known gene names or protein names for a given organism (a protein/gene thesaurus)**

iHOP (Information hyperlinked over proteins)

The image shows two overlapping browser windows from the iHOP website. The top window displays the main iHOP interface with a search bar and navigation links. The bottom window shows a search result for 'TXN', listing several scientific articles with hyperlinks and icons for full text, abstract, and other resources. The search results include:

- Enhanced PubMed/Google query ...**
WARNING: Please keep in mind that gene detection is done automatically and can exhibit a certain error. [Read more](#) about synonym ambiguity and the iHOP confidence value.
- Sentences in this view contain interactions of TXN - Interaction Information is available whenever you see this symbol [icon] - Read more.**
- For a summary overview of the information in this page click here. new**
- Thioredoxin reductase** regulates AP-1 activity as well as **thioredoxin** nuclear localization via active cysteines in response to **ionizing radiation**. [2002]
- Site-directed mutagenesis** of **active site** cysteines in human **thioredoxin** produces competitive inhibitors of human **thioredoxin reductase** and elimination of mitogenic properties of **thioredoxin**. [1994]
- Thioredoxin**-1 is regulated by the ability of the **thioredoxin reductase** to reduce oxidized **thioredoxin**-1 at cysteines 32 and 35. [2006]
- Cell-specific transcription of the **TXNRD1** gene encoding different isoforms of TrxR1 must be taken into account to fully understand the functions of the human **thioredoxin** system. [2004]
- Redox** activity is essential for the growth effects of **thioredoxin**; thus, **thioredoxin reductase** could be involved in **regulating cell growth** through its reduction of **thioredoxin**. [1999]
- C73S was as effective as **Trx** in **stimulating cell growth** and was a comparable substrate for **thioredoxin reductase**. [1996]
- The semisynthetic version of **thioredoxin reductase** that we produce in this manner has $k(\text{cat})$ values ranging from 1500 to 2220 min^{-1} toward **thioredoxin** and has strong peroxidase activity, indicating a functional form of the enzyme. [2006]
- Thioredoxin reductase** (TrxR) is the homodimeric flavoenzyme that catalyzes reduction of **thioredoxin disulfide [?]** (Trx), [2003]
- Human **thioredoxin reductase** contains the redox-active cysteines in the putative **FAD binding** domain and has a dimer interface domain not previously seen with prokaryote and lower eukaryote **thioredoxin** reductases. [1995]
- The mammalian **thioredoxin reductase** (TrxR) is a selenocysteine-containing flavoprotein that regulates the **thioredoxin** system, one of the major systems that maintain the intracellular **redox** balance. [2006]
- Thus, **thioredoxin reductase** presents an attractive target for anticancer drug development to regulate the activity of the **thioredoxin** system. [1997]
- The **active site** of thioredoxin-1 (Trx1) is oxidized in cells with increased reactive oxygen species (ROS) and is reduced by **thioredoxin reductase-1** (TrxR1). [2008]
- In addition, it has been shown that reduced **thioredoxin** displaces the **nitrosourea-inhibitor complex** from the **active site** of **thioredoxin reductase** to fully reactivate enzyme purified from human metastatic **amelanotic melanoma**. [1990]

<http://www.ihop-net.org/UniPub/iHOP/>

PolySearch*

The screenshot shows the PolySearch website interface. The main page on the left contains a description of the tool and instructions for use. The search results page on the right displays a table of results for the query 'thioredoxin'.

PolySearch

A key challenge in biomedical text mining is to handle genes associated with breast cancer". Given that many these kinds of comprehensive searches, we have dev supports more than 50 different classes of queries again or bioinformatic databases. The typical query supported diseases, tissues, cell compartments, gene/protein nam also exploits a variety of techniques in text mining informative abstracts, paragraphs or sentences.

To use this server:

1. Decide which type of search you wish to do
2. Select search restraints from the pull-down menus
3. Press Next
4. Follow the instructions on the input page to fine tur
5. If you need more help or detailed explanations of t

Choose your search type: Given

This page has been viewed 3882 times
2008 © Polyon

PolySearch Results

Query Keywords: thioredoxin
Databases Used: PubMed
Filter Words: accept; accepted; accepting; accepts; acetylate; acetylated; acetylates; acetylation; acetylation; activate; activated ... [Show All](#)

Cutoffs: Z-Score: 0 Relevancy Score: 0 PubMed Hits: 1 R1: 0 R2: 0 R3: 0 R4: 0

Show Scores

Click on any of the headers to sort ascending/descending [Show Full Table \(Printable\)](#)

Z Score	Relevancy Score	Gene/Protein Name	Synonyms	PubMed Hits
25.1	7394 (41,145,196,739)	thioredoxin reductase	ACR 1; PLP; ACR1; AOE166; Alu corepressor 1; Antioxidant enzyme B166; B166; Liver tissue 2D page spot 71B...	503 (41,145,196,739)
9.9	2952 (10,62,86,472)	Trx 1	ADF; TRX 1; TRX1; ATL derived factor; SASP; Surface associated sulphhydryl protein; TRDX; TRX...	223 (10,62,86,472)
9.4	2815 (13,58,90,265)	glutaredoxins	GLRX; GRX; GRX 1; GRX1; Glutaredoxin; Glutaredoxin 1; TTase; TTase 1...	127 (13,58,90,265)
9.3	2780 (25,39,47,320)	thioredoxin binding protein 2	ESTO1027; TBP 2; TBP2; HHCPA78; THIF; TXNIP; Thioredoxin interacting protein; Thioredoxin binding protein 2...	109 (25,39,47,320)
			ASK 1; ASK1; Apoptosis signal regulating kinase	

<http://wishart.biology.ualberta.ca/polysearch>

Rosetta Stone Method

Monomeric proteins that are fused in other organisms tend to be functionally related and physically interacting.

For example, using the Rosetta Stone™ method, it was found that human Nit and Fhit proteins are:

- fused in invertebrates
- form a heterocomplex in mammals

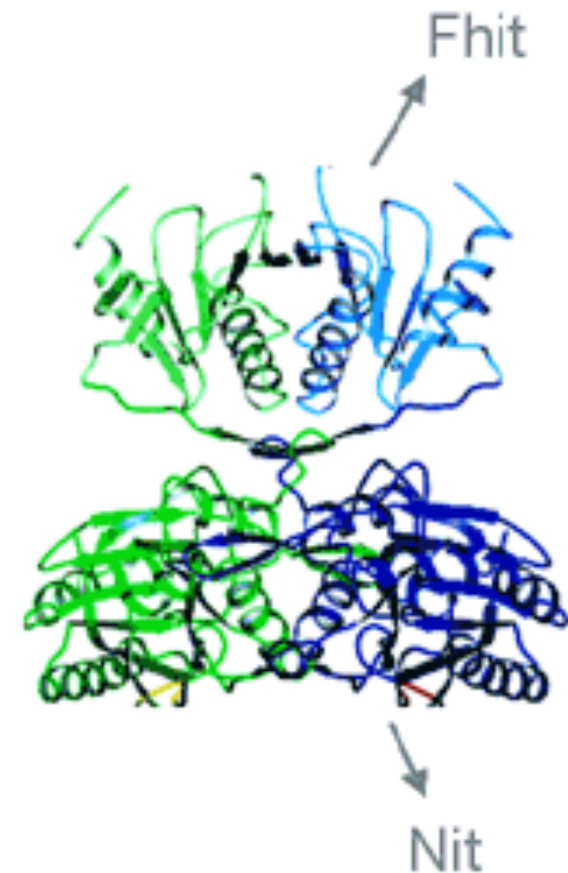
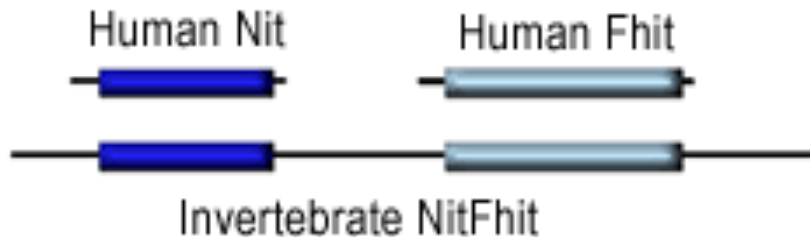

Interologs, Homologs, Paralogs*...

- **Homolog**
 - Common Ancestors
 - Common 3D Structure
 - Common Active Sites
- **Ortholog**
 - Derived from Speciation
- **Paralog**
 - Derived from Duplication
- **Interolog**
 - Protein-Protein Interaction

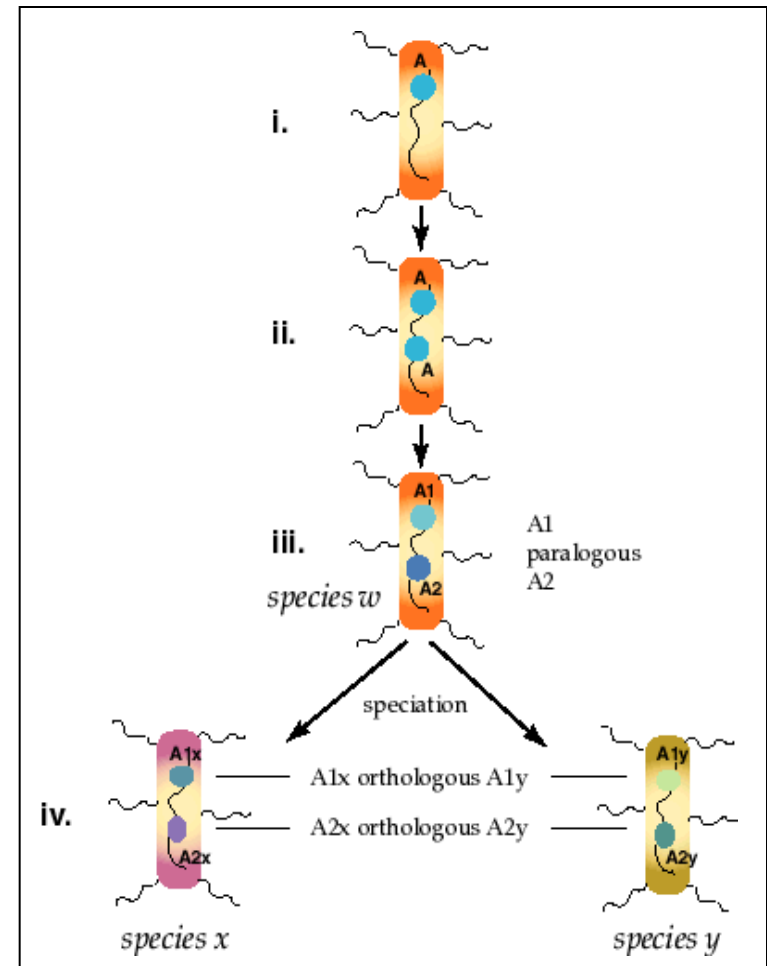

Finding Interologs*

- **If A and B interact in organism X, then if organism Y has a homolog of A (A') and a homolog of B (B') then A' and B' should interact too!**
- **Makes use of BLAST searches against entire proteome of well-studied organisms (yeast, E. coli)**
- **Requires list of known interacting partners**

A Flood of Data

- **High throughput techniques are leading to more and more data on protein interactions**
- **This is where bioinformatics can play a key role**
- **Some suggest that this is the “future” for bioinformatics**

Interaction Databases

- **DIP**
 - <http://dip.doe-mbi.ucla.edu/dip/Main.cgi>
- **MINT**
 - <http://mint.bio.uniroma2.it/mint/>
- **String**
 - <http://string.embl.de/>
- **IntAct**
 - <http://www.ebi.ac.uk/intact/main.xhtml>



DIP Database of Interacting Proteins

Database of Interacting Proteins

Search by: [\[protein\]](#) [\[sequence\]](#) [\[motif\]](#) [\[article\]](#) [\[pathBLAST\]](#) [\[Help\]](#) [\[LOGIN\]](#)

THE DIP DATABASE

The DIP™ database catalogs experimentally determined interactions between proteins. It combines information from a variety of sources to create a single, consistent set of protein-protein interactions. The data stored within the DIP database were curated, both, manually by expert curators and also automatically using computational approaches that utilize the the knowledge about the protein-protein interaction networks extracted from the most reliable, core subset of the DIP data. Please, check the [reference](#) page to find articles describing the DIP database in greater detail.

This page serves also as an access point to other projects related to DIP, such as The Database of Ligand-Receptor Partners ([DLRP](#)) and JDIP.

DIP PAGES

NEWS	Announcements about the most recent additions and changes to the database.
REGISTRATION/ACCOUNT	Registration and account maintenance. Registration is required to gain access to most of the DIP features. Registration is free to the members of the academic community. Trial accounts for the commercial users are also available. Please, consult Terms of Use for further details.
STATISTICS	Detailed information about the current state of the database as well as some statistics on server usage.
SATELLITES	DIP-related projects, such as DLRP and JDIP .
SERVICES	DIP-derived services.
ARTICLES	DIP in press. Both, papers published on DIP as well as a list of publications referring to DIP.
SEARCH	Database search. This is the starting point of the database exploration. Once the initial protein is found through keyword or sequence searches the interaction network can be explored by interactively following the interaction links.

<http://dip.doe-mbi.ucla.edu/dip/Main.cgi>

DIP Query Page

Mozilla Firefox

http://dip.doe-mbi.ucla.edu/dip/Search.cgi?SM=6

Most Visited Getting Started Latest Headlines

http://dip.doe-m...Search.cgi?SM=6



Database of Interacting Proteins



Search by: [\[protein\]](#) [\[sequence\]](#) [\[motif\]](#) [\[article\]](#) [\[pathBLAST\]](#) [\[Help\]](#) [\[LOGIN\]](#)

MOTIF SEARCH

Known Pattern

Database ID

or

Custom Pattern

Motif [\(syntax\)](#)

Done

DIP Results Page



D atabase of I nteracting P roteins

click

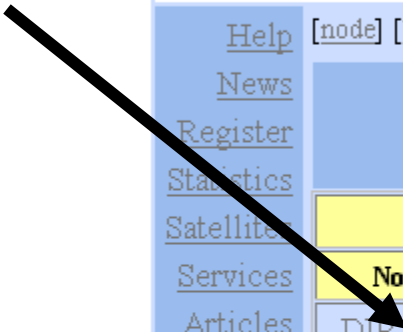

[Help](#) [\[node\]](#) [\[blast\]](#) [\[motif\]](#) [\[article\]](#)

[\[SEARCH:TC\]](#)

[News](#)

[Register](#)

[Statistics](#)

[Satellites](#)

[Services](#)

[Articles](#)

[Search](#)

[Links](#)

[Files](#)

MOTIF SEARCH RESULTS

DIP		Cross Reference			Protein Name/Description
Node	Links	PIR	SWISSPROT	GENBANK	
DIP:96N	●	A36355	EPA2_HUMAN	gi:107496	protein-tyrosine kinase eck p
DIP:165N	●	A41551	-----	gi:108036	vascular endothelial growth f precursor
DIP:303N	●	A60777	-----	gi:320180	keratin 2, type I, hair
DIP:829N	●	S49004	EPA2_MOUSE	gi:1083301	tyrosine kinase Mpk-5
DIP:967N	●	S62935	YNC3_YEAST	gi:2131866	hypothetical protein YNL023
DIP:1079N	●	TXEC	THIO_ECOLI	gi:1070425	Thioredoxin 1 (TRX1) (TRX
DIP:1125N	●	C8HUA	-----	gi:72053	complement C8 alpha chain p
DIP:1376N	●	S46631	ACOX_YEAST	gi:630161	aconitate hydratase homolog

DIP Results Page

DIP:96N - Netscape
File Edit View Go Communicator Help

DIP NODE

DIP 96N	PIR A36355	SwissProt E1
	Name/Description protein-tyrosine kinase eck	
CrossRef	G HSSP: P00523 GO: GO	
	P PIR: A36355	
	D SMART: SM00219 , SM00454 , SM00615 , SM00060 Pfam: PF00 PF00	
	InterPro: IPR006209 , IPR001426 , IPR001660 , IPR0 IPR003961 , IPR001090	
	F PRINTS: PR00109 PROSITE: PS50105 , PS0079	
Organism Homo sapiens	Localization	
EC	Function	
Keywords	phosphoprotein;transmembrane protein;ATP;autophosphorylation;phosphotransferase	

DIP:96N [graph] - Netscape

small [close](#)

MINT Molecular Interaction Database

The screenshot shows a web browser window titled "mint database" with the URL <http://mint.bio.uniroma2.it/mint/Welcome.do>. The browser's address bar includes navigation buttons and a search engine (Google). Below the browser window, the website content is displayed. At the top, there are three links: "HomoMINT: an inferred human network", "Domino: a domain peptide interactions database", and "VirusMINT: a virus protein interactions database". The main navigation bar includes "MINT" (with a logo), "Home", "Search", "Curation", "Statistics", "Download", and "Contacts/Links/Linking".

Statistics:
83275 interactions
29750 proteins
3243 pmids

FEBS Letters special issue: the Digital, Democratic Age of Scientific Abstracts

The spreadsheet for data submission to the FEBS Letters experiment: is available here

Welcome to MINT, the Molecular INTERaction database. MINT focuses on **experimentally verified protein-protein interactions** mined from the scientific literature by expert curators. The full MINT dataset can be freely downloaded.

The curated data can be analyzed in the context of the high throughput data and viewed graphically with the "MINT Viewer".

MINT has signed the **IMEx agreement** (<http://imex.sourceforge.net/>) to share curation efforts and supports the Protein Standard Initiative (PSI) recommendation.

FEBS Letters and the FEBS Journal in collaboration with MINT enhance the content of their articles with the addition of Structured Digital Abstracts

Please, in any articles making use of the data extracted from MINT, refer to *MINT: the Molecular INTERaction database* Andrew Chatr-aryamontri; Arnaud Ceol; Luisa Montecchi Palazzi; Giuliano Nardelli; Maria Victoria Schneider; Luisa Castagnoli; Gianni Cesareni *Nucleic Acids Research* 2006; doi: 10.1093/nar/gkl1950[Abstract]

Logos for ENFIN (Enabling Systems biology), INTERACOME (INTERACOME), IMEx, Proteomics Standards Initiative, and AIRC are displayed at the bottom.

Rss feed not available.

Done

<http://mint.bio.uniroma2.it/mint/>

MINT Results

click

Mozilla Firefox

http://mint.bio.uniroma2.it/mint/search/search.do

Most Visited Getting Started Latest Headlines

http://mint.bio.u...search/search.do

go to: [HomoMINT](#): an inferred human network [Domino](#): a domain peptide interactions database [VirusMINT](#): a virus protein interactions database

MINT [Home](#) [Search](#) [Curation](#) [Statistics](#) [Download](#) [Contacts/Links/Linking](#)

back

Colicin-E7 [Binary Interactions MINT viewer](#)

export partners sequences in Fasta format [Fasta](#) [MINT viewer](#)

colE7: Colicin-E7 (Q47112)
found to interact with 1 partner(s):

protein	evidences	score	direct.	ass.	coloc.	enz.	complex.	HT.
imm Escherichia coli (Q03708)	1	0.43	1					

Uniprotkb AC Q51604, Q47112
Organism **Escherichia coli** (562)
genenames and synonyms cea, colE7,
Domains HNH_nuc (IPR003615), HNH (IPR002711), Cloacin (IPR003058),
 (GO:0009405)
 (GO:0042742)
 (GO:0019835)
Gene Ontology (GO:0008270)
 (GO:0005102)
 (GO:0003676)
 (GO:0004519)
 (GO:0005727)
others Xrefs: [pdb: 7CEI](#), [pdb: 2AXC](#), [pdb: 1ZNV](#), [pdb: 1ZNS](#), [pdb: 1UJZ](#), [pdb: 1PT3](#), [pdb: 1M08](#), [pdb: 2JBG](#), [pdb: 2JB0](#), [pdb: 2JAZ](#), [pdb: 2IVH](#), [pdb: 2ERH](#), [pdb: 1MZ8](#),
keywords Endonuclease, Antimicrobial, Zinc, Bacteriocin, Plasmid, Nuclease, Antibiotic, Metal-binding, Hydrolase, 3D-structure,
ADAN Prediction of protein-protein interAction of moDular domAiNs

direct. = Direct Interaction **ass.** = Physical Association **coloc.** = Colocalization **enz.** = Enzymatic Reaction
complex. = Interaction with more participants **HT.** = High Throughput Experiments (more than 50 interactions)

click on a protein name to access to MINT page of the protein or to the protein xref (uniprot) access the original webpage.

To learn more about the score

Done

back

Colicin-E7 Binary Interactions 
[MINT viewer?](#)

expand protein size score threshold: 0
 Freeze UnFreeze connect Help
 score MITAB PSI 2.5

Uniprotkb AC	Q51604, Q47112,
Organism	Escherichia coli (562)
genenames and synonyms	cea, colE7,
Domains	HNH_nuc (IPR003615), HNH (IPR002711), Cloacin (IPR003058),
Gene Ontology	(GO:0009405) (GO:0042742) (GO:0019835) (GO:0008270) (GO:0005102) (GO:0003676) (GO:0004519) (GO:0005727)
others Xrefs:	pdb: 7CEI, pdb: 2AXC, pdb: 1ZNV, pdb: 1ZNS, pdb: 1UJZ, pdb: 1PT3, pdb: 1M08, pdb: 2JBG, pdb: 2JB0, pdb: 2JAZ, pdb: 2IVH, pdb: 2ERH, pdb: 1MZ8,
keywords	Endonuclease, Antimicrobial, Zinc, Bacteriocin, Plasmid, Nuclease, Antibiotic, Metal-binding, Hydrolase, 3D-structure,
ADAN	Prediction of protein-protein interAction of moDular domAInS

colE7 Escherichia coli

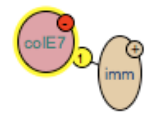

If you experience problems, To learn more about the score

IntAct*

IntAct

http://www.ebi.ac.uk/intact/main.xhtml

Most Visited Getting Started Latest Headlines

EMBL-EBI EB-eye Search All Databases Enter Text Here Go Reset Advanced Search Give us feedback

Databases Tools EBI Groups Training Industry About Us Help Site Index

IntAct

EBI > Databases > Pathways & Networks > IntAct > View

Search: Search Clear Show Advanced Fields MIQL syntax reference

Home Search Interactions (201652) Browse Lists Interactions

IntAct Home

Search IntAct

To perform a search in the IntAct database use the search box in the top left corner. Examples:

- Gene name: e.g. [BRCA2](#)
- UniProtKB Ac: e.g. [Q08609](#)
- UniProtKB Id: e.g. [dmc1](#)
- Pubmed Id: e.g. [10831611](#)

Please supply your feedback to [helpdesk](#). We thank you for your contribution to developing IntAct.

Introduction

IntAct provides a freely available, open source database system and analysis tool. All interactions are derived from literature curation or direct user submissions and are available for download.

Dataset of the month: October

- A zebrafish cell surface interaction network of neural leucine-rich repeat proteins. Soeliner et al. [IntAct](#) [PSI-MI 2.5](#) [PSI-MI 1.0](#) [PSI-MI TAB](#)

Database Search - Microsoft Internet Explorer

File Edit View Favorites Tools Help

Back Forward Stop Home Search Favorites Mail Print

Address http://www.ebi.ac.uk/intact/search/do/hvWelcome

Database Search

Search Results for 'ism7'
(short labels of search criteria matches are highlighted)

Please click on any name to view more detail.

Graph Path InterPro Select all Clear all

Proteins ?	Name	Ac	Gene-Name	Description	Interactions
<input type="checkbox"/>	ism7_yeast	EBI-141	LSM7, N1780, YNL147W, N1202	U6 snRNA-associated Sm-like protein LSM3	14
<input type="checkbox"/>	ism7_mouse	EBI-309131	Lsm7	U6 snRNA-associated Sm-like protein LSM7	1
<input type="checkbox"/>	ism7_human	EBI-348372	LSM7	U6 snRNA-associated Sm-like protein LSM7	26

Graph Path InterPro Select all Clear all

User: INTACTWEB Database: iweb

Please send any questions or suggestions to intact-help@ebi.ac.uk
Last modified: 14-March-2006 11:01 AM by Samuel

Powered by Struts

start CPI06 Local Disk (D:) 2.2ProteInte... 1.1Intro2006... 4.4.ppt Database Se... Internet 4:15 PM

IntAct

IntAct - hierarchView - Microsoft Internet Explorer

Address <http://www.ebi.ac.uk/intact/hierarchView/click.do?AC=EBI-313&now=1147472250293>

HierarchView

Interaction network for ac: [EBI-313](#)

Existing highlight sources for the central protein(s) ?

All (8) GO (6) Interpro (2)

Description	Show	Browse	Count	ID
P:nuclear mRNA splicing, via s			20	GO:000031
C:U4/U6 x U5 tri-snRNP complex			19	GO:004651
F:RNA binding			10	GO:000371

IntAct home
[Back to search](#)

Please send any questions or suggestions to intact-help@ebi.ac.uk
Last modified: 25-August-2005 11:09 AM by alex

Powered by **Struts**

Opening page <http://www.ebi.ac.uk/intact/hierarchView/click.do?AC=EBI-16112&now=1147472297864...>

start | 2 Windows ... | 2.2ProteInte... | 1.1Intro2006... | 4.4.ppt | Database Se... | IntAct - hiera... | 4:19 PM

KEGG Kyoto Encyclopedia of Genes and Genomes*



KEGG - Table of Contents

KEGG2 PATHWAY GENES LIGAND EXPRESSION BRITE XML API DBGET

1. KEGG Databases

Category	Database		Search & Compute	DBGET Search
Pathway information	KEGG PATHWAY Database	XML	Search objects in KEGG pathways Color objects in KEGG pathways Generate possible reaction paths	PATHWAY
Genomic information	KEGG GENES Database	KO	Search similar GENES sequences Search similar GENOME sequences	KO GENES GENOME
Chemical information	KEGG LIGAND Database	RC	Search similar compound structures Search similar glycan structures Search similar reactions	COMPOUND GLYCAN REACTION ENZYME LIGAND

2. KEGG Gene Catalogs

2.1 Genomes in KEGG

Category	Genome	DBGET Search
Organism	Complete genomes in KEGG	GENES
	Complete genomes (taxonomy)	DGENES
Virus	Complete viral genomes	VGENES

start CBRI-2004 KEGG Encyclopedia - ... MINT database - Net... Microsoft PowerPoint ... 5:29 PM

<http://www.genome.ad.jp/kegg/kegg2.html>

KEGG

RNA polymerase - Reference pathway

Go to: [[LinkDB search](#) | [Ortholog Table](#)]

Go to:

RNA POLYMERASE

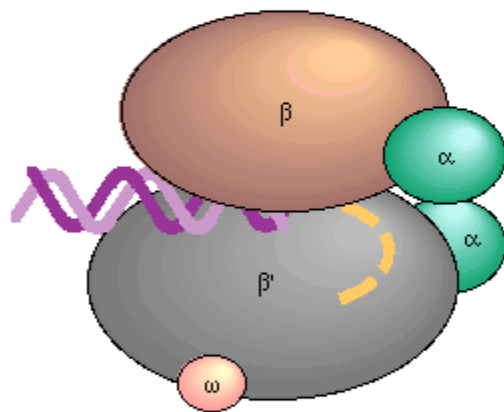

RNA polymerase (*Thermus aquaticus*)

Bacterial

β			
β'	α	ω	δ

Archaeal

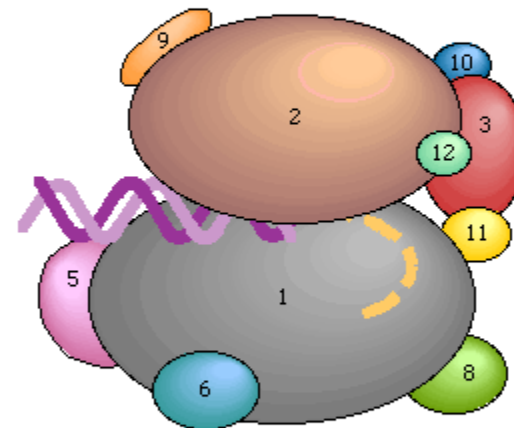

RNA polymerase II (*Saccharomyces cerevisiae*)

Eukaryotic Pol II

B2					
B1	B3	B4	B5	B6	B7
	B8	B9	B10	B11	B12

Eukaryotic Pol III

KEGG

Sulfur metabolism - Reference pathway

Go to: [[LinkDB search](#) | [Ortholog Table](#)]

Go to:

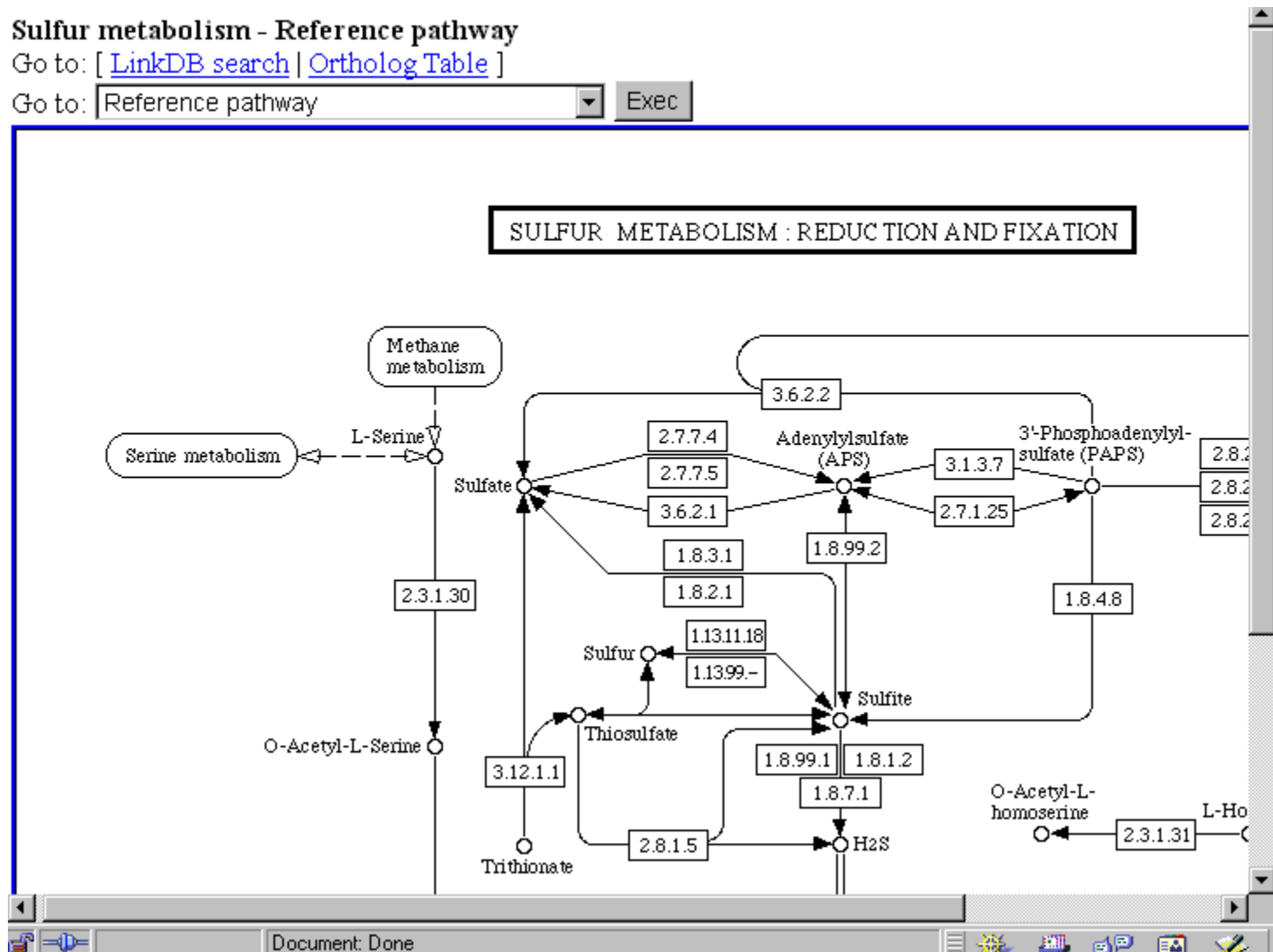

TRANSPATH

Clickable map

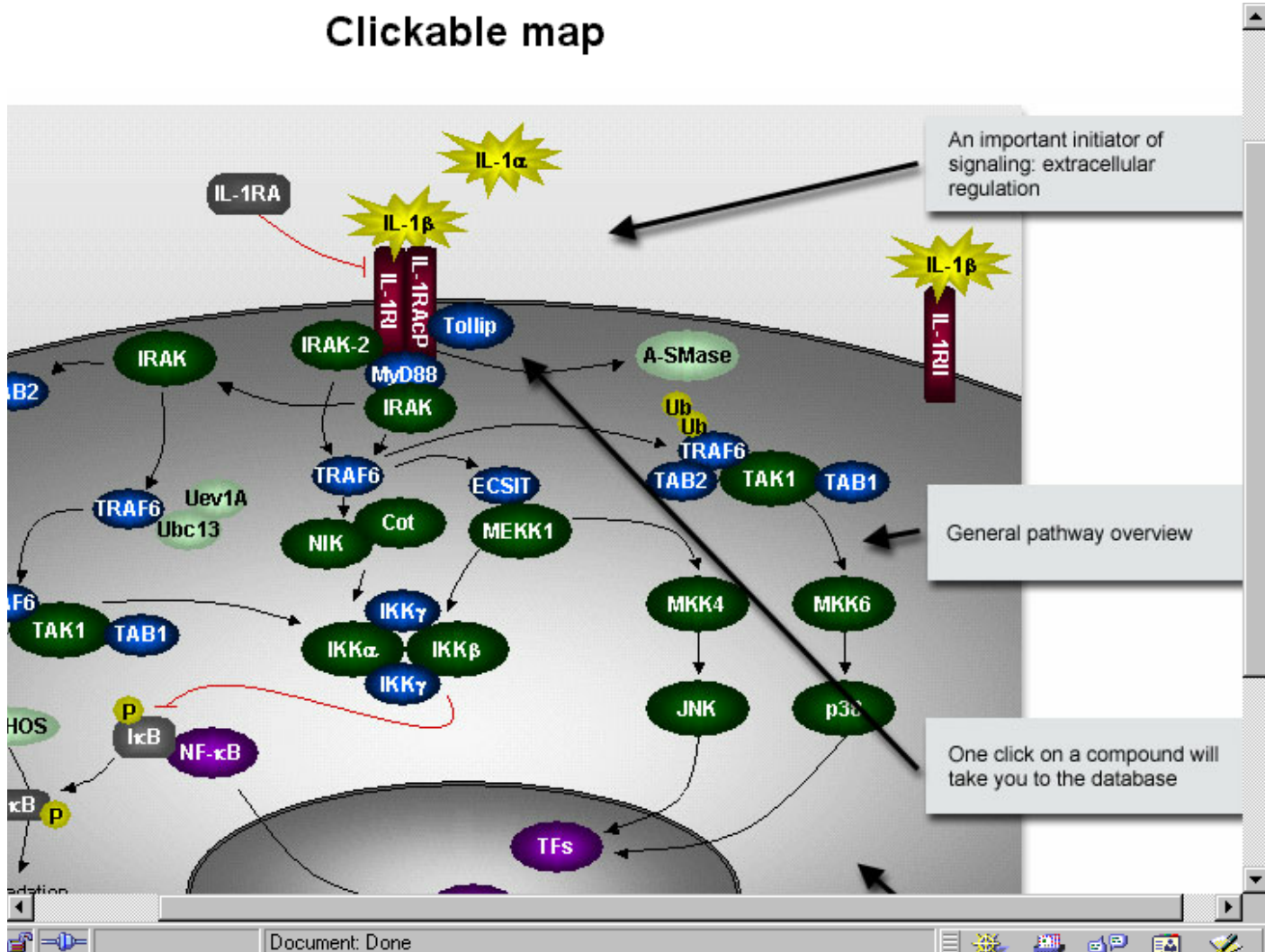

<http://www.gene-regulation.com/pub/databases.html>

BIOCARTA*

- **www.biocarta.com**
- **Go to “Pathways”**
- **Web interactive links to many signalling pathways and other eukaryotic protein-protein interactions**



PATHWAYS ▶ All Pathways



Observe how genes interact in dynamic graphical models. Our online maps depict molecular relationships from areas of active research. In an "open source" approach, this community-fed forum constantly integrates emerging proteomic information from the scientific community. It also catalogs and summarizes important resources providing information for over 120,000 genes from multiple species. Find both classical pathways as well as current suggestions for new pathways.

ALL PATHWAYS

A

- ▶ Acetylation and Deacetylation of RelA in The Nucleus [H](#) [M](#)
 - ▶ Actions of Nitric Oxide in the Heart [H](#)
 - ▶ Activation of cAMP-dependent protein kinase, PKA [H](#) [M](#)
- ▶ Activation of Csk by cAMP-dependent Protein Kinase Inhibits Signaling through the T Cell Receptor [H](#) [M](#)
 - ▶ Activation of PKC through G protein coupled receptor [H](#) [M](#)
- ▶ Activation of Src by Protein-tyrosine phosphatase alpha [H](#) [M](#)
 - ▶ Acute Myocardial Infarction [H](#)
 - ▶ Adhesion and Diapedesis of Granulocytes [H](#)
 - ▶ Adhesion and Diapedesis of Lymphocytes [H](#)
 - ▶ Adhesion Molecules on Lymphocyte [H](#) [M](#)
 - ▶ ADP-Ribosylation Factor [H](#) [M](#)
 - ▶ Agrin in Postsynaptic Differentiation [H](#) [M](#)
 - ▶ Ahr Signal Transduction Pathway [H](#) [M](#)
 - ▶ AKAP95 role in mitosis and chromosome dynamics [H](#) [M](#)
 - ▶ AKT Signaling Pathway [H](#) [M](#)
 - ▶ ALK in cardiac myocytes [H](#)
- ▶ Alpha-synuclein and Parkin-mediated proteolysis in Parkinson's disease [H](#) [M](#)
 - ▶ Alternative Complement Pathway [H](#) [M](#)
- ▶ Angiotensin II mediated activation of JNK Pathway via Pyk2 dependent signaling [H](#) [M](#)
 - ▶ Angiotensin-converting enzyme 2 regulates heart function [H](#) [M](#)
 - ▶ Anthrax Toxin Mechanism of Action [H](#)

Visualizing Interactions



#754
CELLULAR TUMOR ANTIGEN P53

[Binary Interactions](#) - [Pathways](#) - [Complexes](#)

ID	754
AC	P04637 (S)

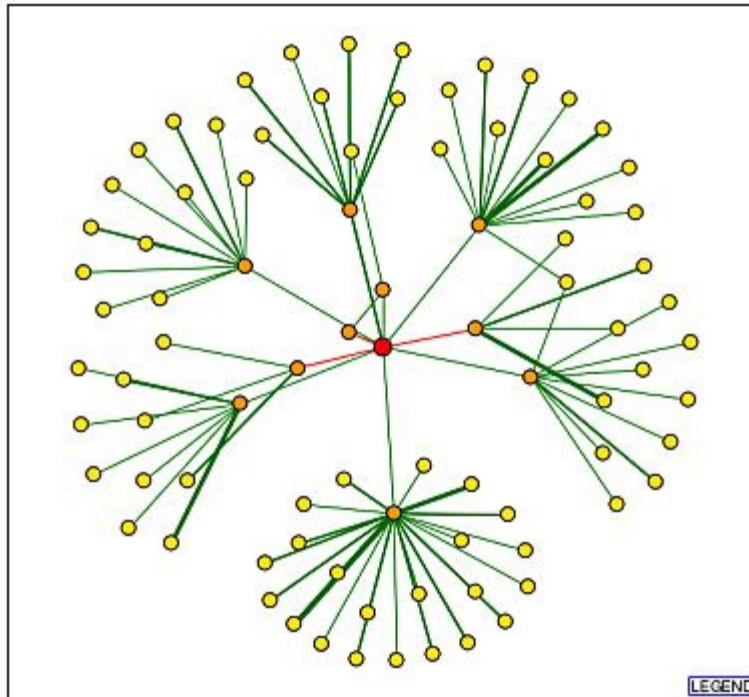

DIP

with arrest or apoptosis depending on whether these sites are involved in tumor suppressor genes that acts to negatively regulate cell growth. One of the activated genes is an oncogene that is mediated either by a mutation or by a loss of bcl-2 expression.

observed in eb-1 cell line

[11 CAA26306 AAC12971](#)

[13AL 1TSE 1AJE 1PES 1PET](#)

or Nuclear protein
Disease mutation Polymorphism

MINT Viewer v1.1

Freeze All UnFreeze All Help

CELLULAR TUMOR ANTIGEN P53

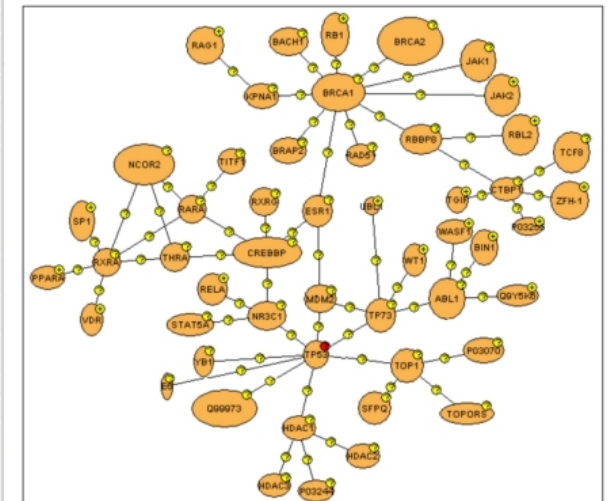

MINT

Visualizing Interactions*

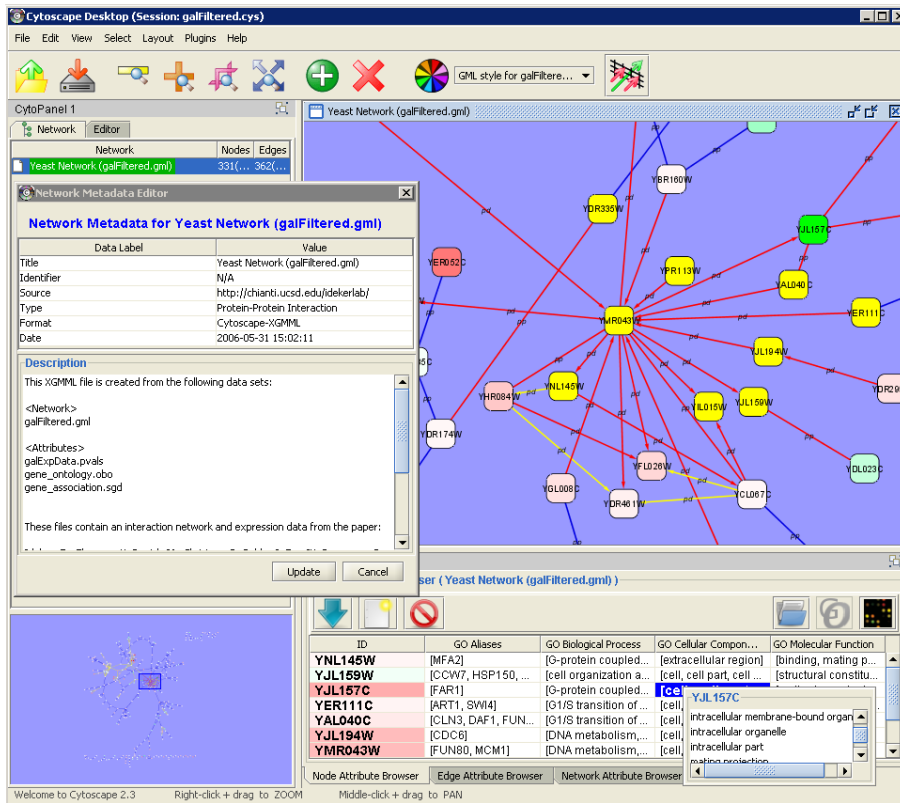

Cytoscape (www.cytoscape.org)

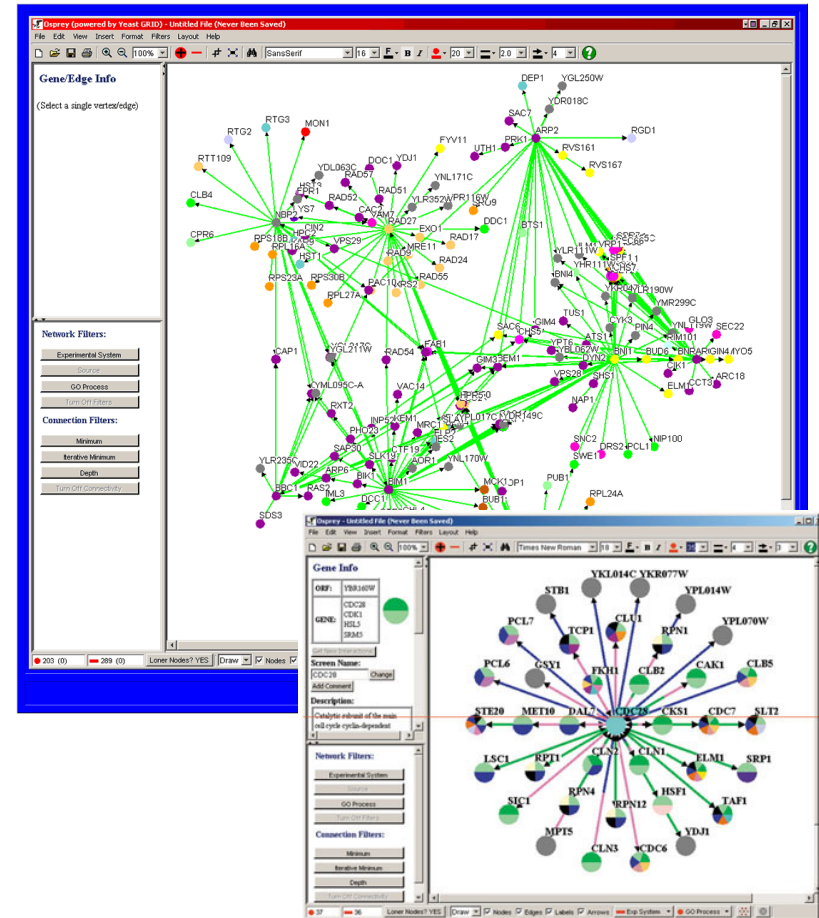

Osprey <http://biodata.mshri.on.ca/osprey/servlet/Index>

Pathway Visualization with BioCarta*

The screenshot shows the BioCarta website interface. The top navigation bar includes 'FEATURES', 'PATHWAYS', 'CUSTOM SERVICES', 'GENES', 'PRODUCTS', and 'LOGIN'. The main content area is titled 'PATHWAYS > All Pathways' and contains a list of pathways under the heading 'ALL PATHWAYS'. A detailed signaling pathway diagram is overlaid on the right side of the screenshot, showing the interaction of various proteins and molecules in response to extracellular stimuli.

ALL PATHWAYS

- ▶ Acetylation and Deacetylation of RelA in The Nucleus [H](#) [M](#)
 - ▶ Actions of Nitric Oxide in the Heart [H](#) [M](#)
- ▶ Activation of Csk by cAMP-dependent Protein Kinase Inhibits Signaling through the T Cell [H](#) [M](#)
 - ▶ Activation of PKC through G protein coupled receptor [H](#) [M](#)
- ▶ Activation of Src by Protein-tyrosine phosphatase alpha [H](#) [M](#)
 - ▶ Acute Myocardial Infarction [H](#)
 - ▶ Adhesion and Diapedesis of Granulocytes [H](#)
 - ▶ Adhesion and Diapedesis of Lymphocytes [H](#)
 - ▶ Adhesion Molecules on Lymphocyte [H](#) [M](#)
 - ▶ ADP-Ribosylation Factor [H](#) [M](#)
 - ▶ Agrin in Postsynaptic Differentiation [H](#) [M](#)
 - ▶ Ahr Signal Transduction Pathway [H](#) [M](#)
 - ▶ AKAP95 role in mitosis and chromosome dynamics [H](#) [M](#)
 - ▶ AKT Signaling Pathway [H](#) [M](#)
 - ▶ ALK in cardiac myocytes [H](#)
- ▶ Alpha-synuclein and Parkin-mediated proteolysis in Parkinson's disease [H](#) [M](#)
 - ▶ Alternative Complement Pathway [H](#) [M](#)
- ▶ Angiotensin II mediated activation of JNK Pathway via Pyk2 dependent signaling [H](#) [M](#)
 - ▶ Angiotensin-converting enzyme 2 regulates heart function [H](#) [M](#)
 - ▶ Anthrax Toxin Mechanism of Action [H](#)

Signaling Pathway Diagram:

The diagram illustrates the signaling pathway from extracellular stimuli to nuclear responses. Extracellular stimuli include Lipoproteins (BLP, PGN, LAM, Mannans), Lipopolysaccharides (LPS), CpG DNA, Poly (I:c), and Imiquimod, R848. These bind to receptors such as CD14, TLR2, TLR6, MD-2, TLR4, TLR9, TLR3, TLR7, and TLR10. The signaling cascade involves MyD88, IRAK, TRAF6, TAK1, TAB2, TAB1, MEK3, MEK6, p38, JNK1, IKKα, IKKβ, IKKγ, NF-κB, and PPARα. The pathway leads to the activation of NF-κB and JNK1 in the nucleus, resulting in the production of pro-inflammatory cytokines (IL12, IL1, TNF-α) and the regulation of cell-mediated immunity, T cells, influence adaptive immune response, apoptosis of host cells, and bacterial death. The diagram is labeled 'Monocytes/Macrophages, Dendritic cells, Intestinal Epithelial & Endothelial cells'.

<http://www.biocarta.com/genes/allpathways.asp>

Pathway Database Comparison*

	KEGG	BioCyc	GenMAPP	Reactome	BioCarta	TransPATH
Organisms	181 (varied)	E.Coli, human (20 others)	Human, mouse, rat, fly, yeast	Human, rat, mouse, chicken, fugu, zebrafish	Human, mouse	Human, mouse
Pathway types	Metabolic, genetic, signaling, complexes	Metabolic, complexes	Metabolic, signaling, complexes	Metabolic, signaling, complexes	Metabolic, signaling, complexes	Signaling, genetic
Tools/ viewing	linked to from many	Pathway Tools	GenMAPP	PathView applets	none	Pathway Builder
Images	Static box flow diagrams	Detailed flow diagrams	Static box flow diagrams	“starry sky”	“Graphics rich” cell diagrams	Graphics rich cell diagrams
Download Formats	KGML XML SBML	BioPax SBML	MAPP format	SBML MySQL	Just images	Proprietary XML files

Other Databases

The JCB Protein-Protein Interaction Website (PPI): Databases

http://www.imb-jena.de/jcb/ppi/jcb_ppi_databases.html

Most Visited Getting Started Latest Headlines

The JCB Protein-Protein Interactio...

Databases & Data Collections / Webtools

Last update: May 1, 2009

Databases & Data Collections

[Experimental Data](#) [Predictions](#) [Related Domain, Pathway and Network Databases](#)

Webtools

Databases & Data Collections

Experimental Data

AllFuse (*European Bioinformatics Institute*)

- functional association of proteins in complete genomes (unavailable ??)

ASEdb

- Alanine Scanning Energetics DataBase**
- database of hotspots in 3D protein structures

Bacteriome.org (*University of Toronto*)

- bacterial protein interaction database
- database integrating physical (protein-protein) and functional interactions within the context of an *E. coli* knowledgebase

BID (*A & M University Texas*)

- Binding Interface Database**

BioGRID (*Samuel Lunenfeld Research Institute*)

- The General Repository for Interaction Datasets**
- database of genetic and physical interactions

BOND (*Thomson Corp.*)

Done

http://www.imb-jena.de/jcb/ppi/jcb_ppi_databases.html

Functional Proteomics

- **Mixture of experimental and computational techniques**
- **Trying to reach a point where functions and interactions can be predicted and modelled**
- **The future of proteomics (and bioinformatics)**

Final Exam

- **Short answer to long answer format**
- **Bring calculators**
- **Typically one question from each of the lectures in the last $\frac{1}{2}$ of the course**
- **Some questions/answers will involve recall**
- **Most questions require analysis or some thinking or explaining**
- **Dec. 13, 9:00 am - 2 hours not 3 hours**
- **This room, M-229**

Typical Questions

- **What is the correlation between protein expression and transcript expression? Provide three reasons to explain the difference**
- **Describe the algorithm or diagram a flow chart for XXXXX**
- **Explain the differences and similarities between functional proteomics and structural proteomics**

Typical Questions

- Here is some YYYY data from some XXXX experiment – interpret it and explain what it means
- Explain the difference between the XXX algorithm and the YYY algorithm. Give some examples or provide an illustration
- Here are two small molecules, calculate their difference distance matrix, show calculations. What is the difference between the two?

Typical Questions

- **Define normalization. Provide 3 examples. Show equations or algorithms**
- **What are the three different kinds of proteomics, compare and contrast**
- **Show the equations and explain the algorithm you would use to rotate, expand and translate this small molecule**